

WAREHOUSE/ORDER-PICKING/ TRANSPORT CONTAINERS

2020
2021

Extract from general catalog

[ssi-schaefer.com](https://www.ssi-schaefer.com)

Chapter A



SSI SCHÄFER

Containers from SSI SCHAEFER provide endless diversity

SSI SCHAEFER's impressive range of warehouse, order picking and transport containers includes more than 2,000 different types, designs and sizes.

All product developments within our portfolio draws on experience gained from innumerable practical applications. You can rely on these products because development based on real

usage under demanding conditions is better than any simulated tests. You can be sure that the design and material quality of every type lives up to our promises.

Benefit from SSI SCHAEFER's expertise because we understand storage.

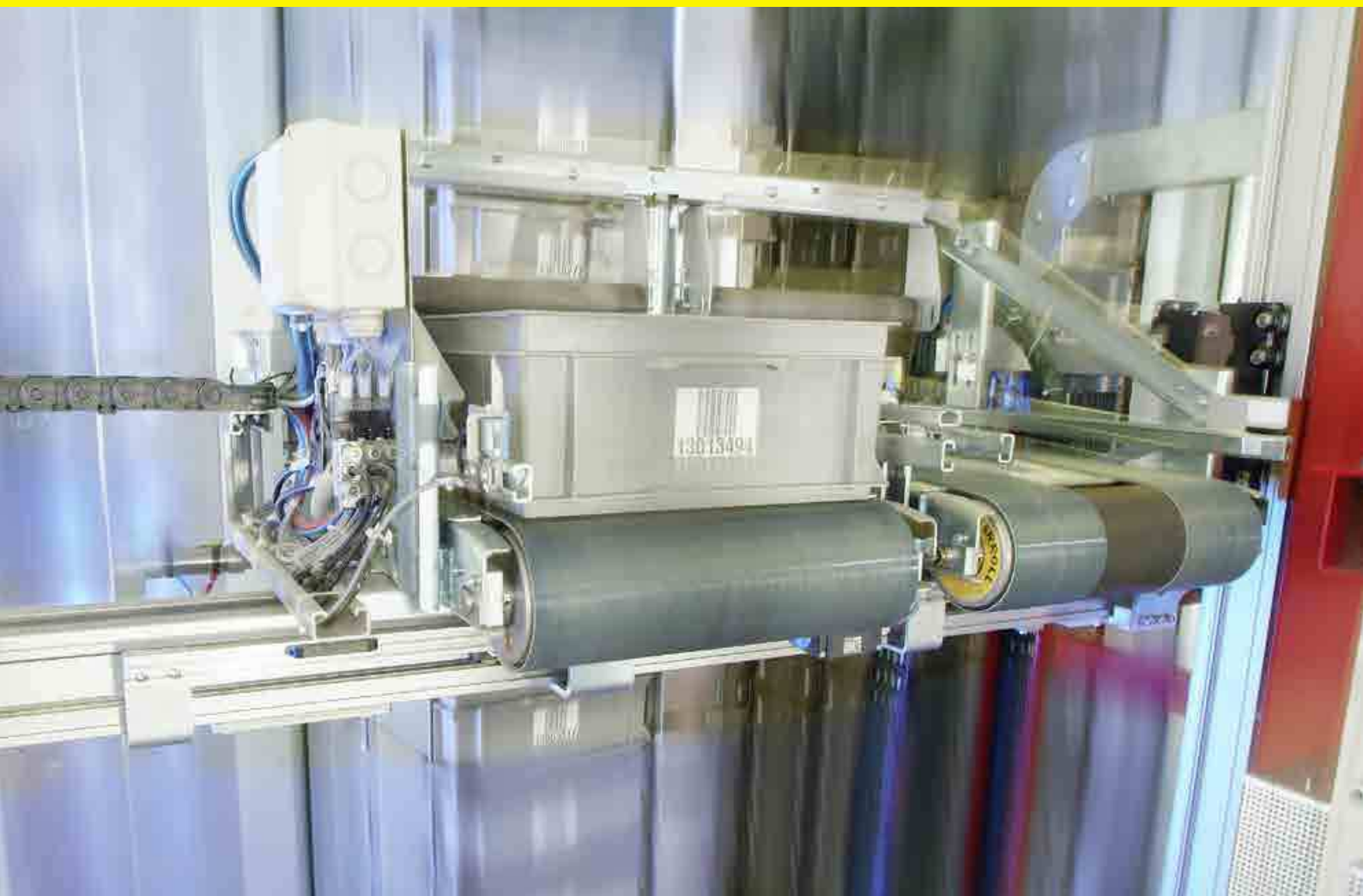

General note regarding dimensions in this catalog chapter:

all SSI SCHAEFER plastic containers are manufactured to **within the plastic shaped parts tolerance specified by DIN 16 742.**



Semi-open front storage containers page **A2**

Lager-Fix containers
made of plastic and conductive polypropylene

Stackable transport containers **A6**

14/ 6 range made of plastic and conductive polypropylene A7

Shelf containers **A10**

Plastic shelf containers A10

Euro dimension containers **A14**

ELB range	A14
EF range	A16
MF range	A22
LTB range	A24
LTF range	A26
Insert boxes	A28
QX range	A34
KLT container system (R-, RL-, C-, F-KLT)	A36

Foldable / collapsible containers **A42**

ECOflex ECT folding boxes	A42
Foldable-collapsible FK containers	A44

Nesting storage and transport containers **A46**

KMB containers	A47
KS tapered stack and nest containers	A50
EUROFIX Boxes	A51
Fix-Box	A52

Sheet steel boxes and containers **A54**

14/7 range sheet steel semi-open front storage containers	A56
14/6 range sheet steel stackable transportation containers	A58
Sheet steel shelf containers	A60
Sheet steel transport and stacking containers	A61
Sheet steel Lager-Fix containers, sheet steel post pallets and flat steel pallets	A62

Boxes /
containers

Modular
shelving

Longspan
racking

Pallet
racking

Cantilever
racking

Mezzanines /
platforms

On-line shelving /
KDR shelving

Semi-automated
solutions

Logistics
systems

Appendix

Semi-open front storage containers – the practical solution

















SSI SCHAEFER's containers are designed to integrate perfectly into variety of different rack systems. Thanks to their coordinated dimensions, they can be specifically combined to fit the individual rack fields independently of their purpose.

SSI SCHAEFER's containers create the perfect storage system regardless of whether they are used in high bay racking systems, single or multi-tier platform systems or fully automated small parts storage.



Plastic semi-open front storage containers – LF range

Item	Internal dimensions (base) L x W x Usable H (mm)	Volume (liters)	PU	Order no.				Order no.
								
 LF 110 PP	65 x 91 x 44	0.26	50	1142031	1142032	1142033	1142034	-
LF 110 PPL				-	-	-	-	1142038
 LF 110 M PP	with injection-molded central divider			1142041	1142042	1142043	1142044	-
LF 110 M PPL				-	-	-	-	1142048
 LF 210 ZW PP	136 x 88 x 44	0.5	50	6991	6992	6993	6994	-
LF 210 ZW PPL				-	-	-	-	6998
 LF 211 ZW PP	135 x 88 x 67	0.9	50	92191	92192	92193	92194	-
LF 211 ZW PPL				-	-	-	-	92198
 LF 221 CS PP	191 x 128 x 111	2.7	40	91281	91282	91283	91284	-
LF 221 CS PPL	with grooves for panels CS 221			-	-	-	-	91288
 LF 221 ZW CS PP	with grooves for dividers and panels CS 221			91291	91292	91293	91294	-
LF 221 ZW CS PPL				-	-	-	-	91298
 LF 321 G PP	294 x 182 x 133	7.5	28	91921	91922	91923	91924	-
LF 321 G PPL	with recessed hand grip			-	-	-	-	91928
 LF 321 G ZW PP	with recessed hand grip and grooves for dividers			95521	95522	95523	95524	-
LF 321 G ZW PPL				-	-	-	-	95528
 LF 322 G PP	294 x 183 x 185	10.4	20	92011	92012	92013	92014	-
LF 322 G PPL	with recessed hand grip			-	-	-	-	92018
 LF 322 G ZW PP	with recessed hand grip and grooves for dividers			95511	95512	95513	95514	-
LF 322 G ZW PPL				-	-	-	-	95518

Order no. = on stock

RED GREEN YELLOW BLUE

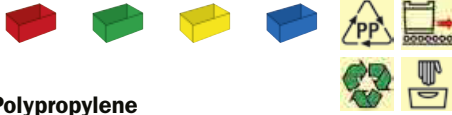

- **Polypropylene**
resistant to most oils, acidic and alkaline solutions, sound insulation effect when used on conveying sections, when used properly dimensionally stable from -20° to +100°C
- **Keeps its shape and robust**
- **Smooth interior walls**
for easy cleaning
- **Recessed handle on the rear wall**
for safe manual transport
- **Flexible due to partitioning options**
- **Stacking lug**
for safe stacking
- **Stackable**
with 14/7 range made of steel, 14/6 range made of plastic and steel
- **Extensive range of accessories**
for customized bin designs

Lager-Fix containers, plastic



Plastic semi-open front storage containers – LF range

Item	Internal dimensions (base) L x W x Usable H (mm)	Volume (liters)	PU	Order no.	Order no.				
LF 351 ZW PP	268 x 442 x 132	17.0	10	1142051	1142052	1142053	1142054	-	-
LF 351 ZW PPL	with grooves for dividers ZW 351			-	-	-	-	1142058	
LF 421 G PP	331 x 158 x 142	7.8	1	79251	79252	79253	79254	-	-
LF 421 G PPL	with recessed hand grip			-	-	-	-	79258	
LF 511 G PP	448 x 123 x 127	7.6	20	91831	91832	91833	91834	-	-
LF 511 G PPL	with recessed hand grip			-	-	-	-	91838	
LF 511 G ZW PP	with recessed hand grip and grooves for dividers			92111	92112	92113	92114	-	-
LF 511 G ZW PPL				-	-	-	-	92118	
LF 531 G PP	445 x 279 x 130	16.5	14	91991	91992	91993	91994	-	-
LF 531 G PPL	with recessed hand grip			-	-	-	-	91998	
LF 531 G ZW PP	with recessed hand grip and grooves for dividers			92181	92182	92183	92184	-	-
LF 531 G ZW PPL				-	-	-	-	92188	
LF 532 G PP	445 x 279 x 185	23.5	10	92001	92002	92003	92004	-	-
LF 532 G PPL	with recessed hand grip			-	-	-	-	92008	
LF 532 G ZW PP	with recessed hand grip and grooves for dividers			95501	95502	95503	95504	-	-
LF 532 G ZW PPL				-	-	-	-	95508	
LF 533 G PP	444 x 277 x 285	38.0	1	92081	92082	92083	92084	-	-
LF 533 G PPL	with recessed hand grip			-	-	-	-	92088	
LF 533 G ZW PP	with recessed hand grip and grooves for dividers			92091	92092	92093	92094	-	-
LF 533 G ZW PPL				-	-	-	-	92098	
LF 543 G PP	445 x 425 x 277	57.0	1	1142174	1142173	1142172	1142171	-	-
LF 543 G PPL	with recessed hand grip			-	-	-	-	92108	
LF 543 G ZW PP	with recessed hand grip and grooves for dividers			1142164	1142163	1142162	1142161	-	-
LF 543 G ZW PPL				-	-	-	-	95568	
LF 743 PP	615 x 425 x 278	74.0	1	1142061	1142062	1142063	1142064	-	-
LF 743 PPL				-	-	-	-	1142068	

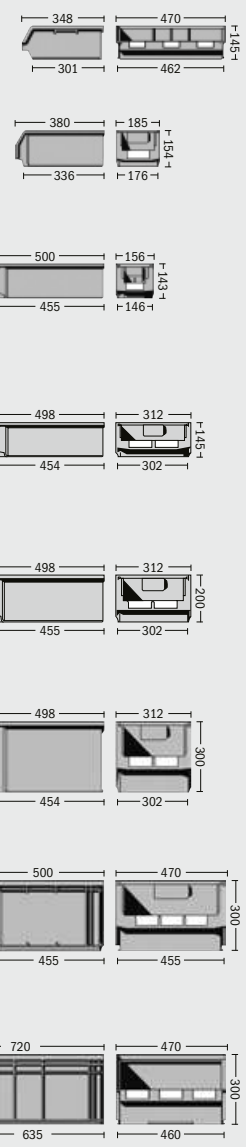

Order no. = not on stock

Boxes / containers
Modular shelving
Longspan racking
Pallet racking
Cantilever racking
Mezzanines / platforms
On-line shelving / KDR shelving
Semi-automated solutions
Logistics systems
Appendix

LF range accessories

**Dust lids**

Made of transparent plastic, angled at the front, closed.

Item	for containers	PU	Order no.
DC 211	LF 211 ZW	10	93240
DC 221	LF 221 CS / ZW CS	10	93230
DC 321	LF 321 G / G ZW	10	93140
DC 322	LF 322 G / G ZW	10	93130
DC 511	LF 511 G / G ZW	10	93290
DC 531	LF 531 G / G ZW	10	93220
DC 532	LF 532 G / G ZW	10	93120

Dust lids

Only for LF 322 and LF 532.

Made of gray or transparent plastic. Open order picking side.

Item	for containers	Type	PU	Order no.
DL 322	LF 322 G / G ZW	Transparent	10	93200
LF 32-DL	LF 321 / LF 322 G / G ZW	Gray	10	55385
DL 532	LF 532 G / G ZW	Transparent	10	93190
LF 53-DL	LF 531 / LF 532 / LF 533 G / G ZW	Gray	10	55395

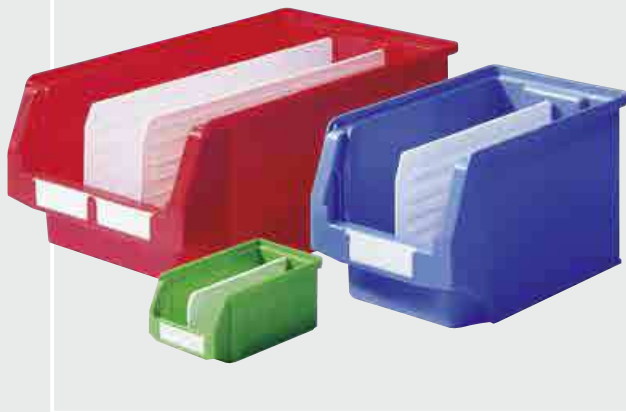
**Dividers**

Polystyrene, white. For dividing containers with moulded grooves. Stackability remains ensured. PU: 10 items.

Item	for containers	PU	Order no.
ZW-K 210	LF 210 ZW, four-way partitioning (1x length-, 1x crosswise)	10	91900
ZW 211	LF 211 ZW	10	92990
ZW 221	LF 221 ZW CS	10	91910
ZW 321 G	LF 321 G ZW	10	95550
ZW 322 G	LF 322 G ZW	10	95540
ZW 351	LF 351 ZW	10	1142030
LF-T 511	LF 511 G ZW, lengthwise divider	10	92120
RKT 300	LF 511 G ZW, crosswise divider	10	14720
ZW 531 G	LF 531 G ZW	10	93280
ZW 532 G	LF 532 G ZW	10	95530
ZW 533 G/543 G	LF 533 G ZW / LF 543 G ZW	10	93080

**Slide-in panels**

For LF containers, made of transparent high quality plastic to protect against dust. With retaining mechanism to prevent anything from falling out of full containers. Can be opened when stacked. Additional, large label holder. Can also be used in stacks, with carry rods and dividers.

Item	for containers	PU	Order no.
CS 321-L	LF 321 G / G ZW	10	93110
CS 322-L	LF 322 G / G ZW	10	93030
CS 531-L	LF 531 G / G ZW	10	91520
CS 532-L	LF 532 G / G ZW	10	93020
CS 533-L	LF 533 G / G ZW	10	93090

Sliding flap panels

Made of transparent high quality plastic to protect against dust. The flaps are locked onto the container using two fixing clips, included in the scope of delivery, preventing them from being lost.

Item	for containers	PU	Order no.
CS 221-K	LF 221 CS / ZW CS	10	91220
CS 321-K	LF 321 G / G ZW	10	91480
CS 322-K	LF 322 G / G ZW	10	91490
CS 531-K	LF 531 G / G ZW	10	91530
CS 532-K	LF 532 G / G ZW	10	91500
CS 533-K	LF 533 G / G ZW	10	91510

Order no. = on stock

LF range accessories

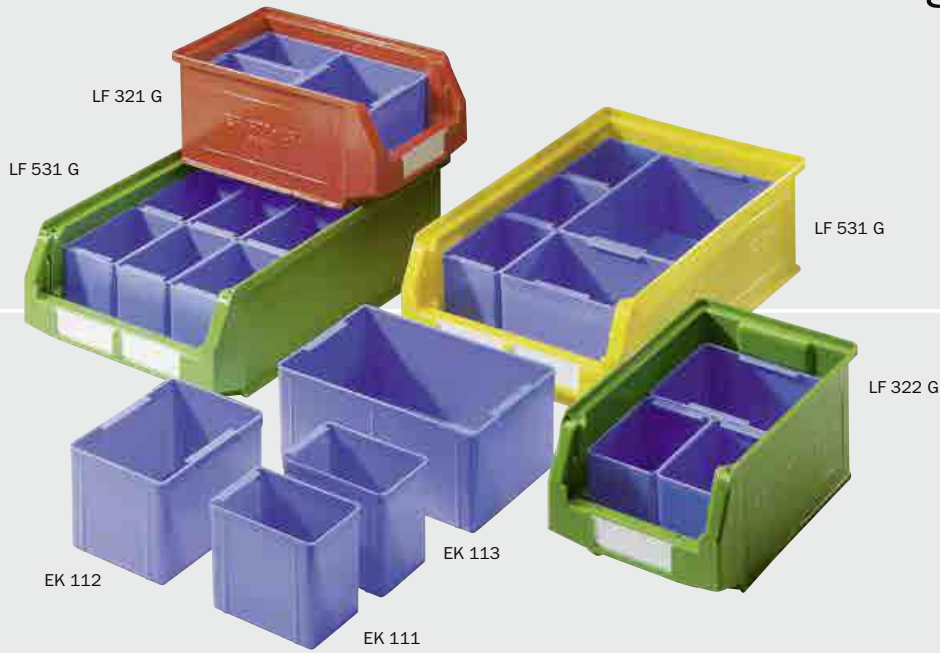

Insert boxes

Made of blue polystyrene or black conductive PPL (for LF 321 G, LF 322 G, LF 531 G, LF 532 G and LF 533 G).

Item	PU	Order no.	
EK 111	48	22644	—
EK 111 PPL	48	—	22648
EK 112	40	22634	—
EK 112 PPL	40	—	22638
EK 113	36	22624	—
EK 113 PPL	36	—	22628

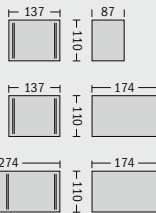

Suggested partitioning with insert boxes for LF 531 G, LF 532 G and LF 533 G



Suggested partitioning with insert boxes for LF 321 G and LF 322 G

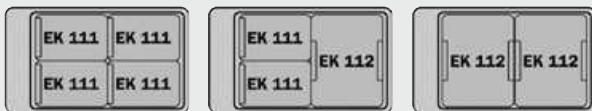

Bars for lifting

Made of high-strength black plastic. Designed for containers with heavy contents. Easy to retrofit. PU: 10 items

Item	for containers	PU	Order no.
TS 322	LF 321 / LF 322 G / G ZW	10	93010
TS 531	LF 531 / LF 532 / LF 533 G / G ZW	10	93250
TS 543	LF 543 G / G ZW / LF 743	10	95590



Order no. = not on stock

Boxes / containers

Modular shelving

Longspan racking

Pallet racking

Cantilever racking

Mezzanines / platforms

On-line shelving / KDR shelving

Semi-automated solutions

Logistics systems

Appendix

Stackable transport containers for specific warehousing applications



The 14/6 range stackable transport containers are made of plastic and are ideal for both intra-company transport and shipping. They also perfectly fit all SSI SCHAEFER rack systems.

The diverse range of different sizes makes this range of containers highly adaptable to the customer's specific warehousing applications.

The plastic 14/6 range is both compatible and stackable with the 14/6 steel containers along with the 14/7 range made of steel and the plastic LF series.

The fully closed walls allow the boxes to be completely filled. In addition, the sturdy stacking rim and the flat base ensure the safest possible stacking for both intra-company and external transport.



The stacking ratio



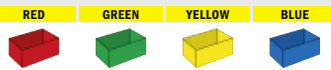

- **Polypropylene**
resistant to most oils, acidic and alkaline solutions, sound insulation effect when used on conveying sections, when used properly dimensionally stable from -20° to +100°C
- **Keeps its shape and robust**
- **Smooth interior walls**
for easy cleaning
- **Recessed handle on the short sides**
for safe manual transport
- **Stackable**
with LF range made of plastic,
14/7 series made of steel,
14/6 range made of steel



	normal PE/PP	PPL
Specific contact resistance	10 ¹⁸ Ohm x cm <	10 ⁹ Ohm x cm
Specific surface resistance	10 ¹⁴ Ohm	10 ⁴ Ohm



Stackable transport containers made of plastic/conductive PPL – 14/6 range

Item	Internal dimensions (base) L x W x Usable H (mm)	Volume (liters)	PU	Order no.	Order no.
14/6-4 PP	190 x 123 x 110	2.5	40	8151 8152 8153 8154	—
14/6-4 PPL				—	8158
14/6-3 PP	285 x 183 x 133	7.0	20	8121 8122 8123 8124	—
14/6-3 PPL				—	8128
14/6-3 S PP	286 x 182 x 182 with document holder on the short side	9.3	1	14131 14132 14133 14134	—
14/6-3 S PPL				—	14138
14/6-2 F PP	430 x 279 x 59	8.0	30	15491 15492 15493 15494	—
14/6-2 F PPL				—	15498
14/6-2 G PP	429 x 279 x 89	10.3	20	14121 14122 14123 14124	—
14/6-2 G PPL				—	14128
14/6-2 H PP	428 x 278 x 104 with label holders	12.0	16	14361 14362 14363 14364	—
14/6-2 H PPL				—	14368
14/6-2 PP	426 x 278 x 182 with label holders	21.0	10	8091 8092 8093 8094	—
14/6-2 PPL				—	8098
14/6-230 PP	425 x 275 x 218 with overhang hand grip on request	26.0	10	15751 15752 15753 15754	—
14/6-230 PPL				—	15758
14/6-2 Z PP	423 x 272 x 282 with label holders	33.0	1	14371 14372 14373 14374	—
14/6-2 Z PPL				—	14378
14/6-1 PP	608 x 426 x 278 with label holders	71.0	4	95301 95302 95303 95304	—
14/6-1 PPL				—	95308

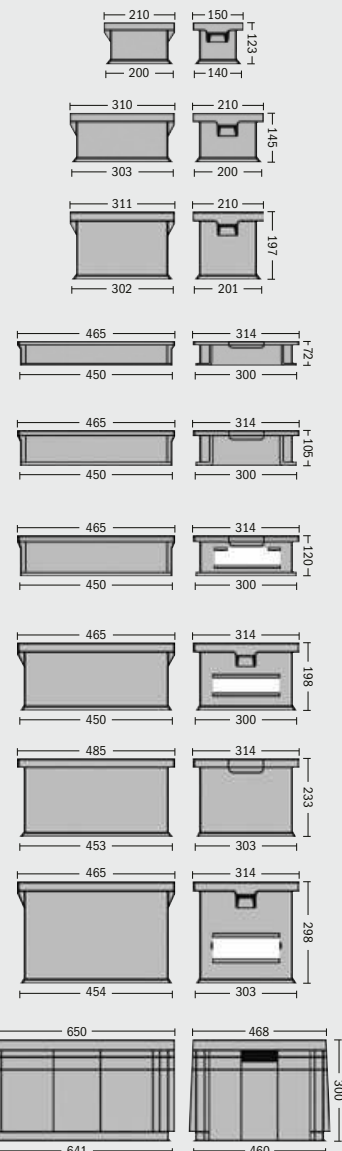

Order no. = on stock

Order no. = not on stock

Boxes / containers

Modular shelving

Longspan racking

Pallet racking

Cantilever racking

Mezzanines / platforms

On-line shelving / KDR shelving

Semi-automated solutions

Logistics systems

Appendix

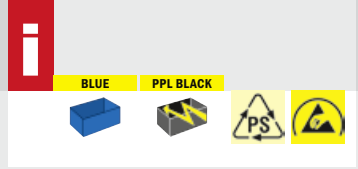

Accessories for 14/6 range, plastic

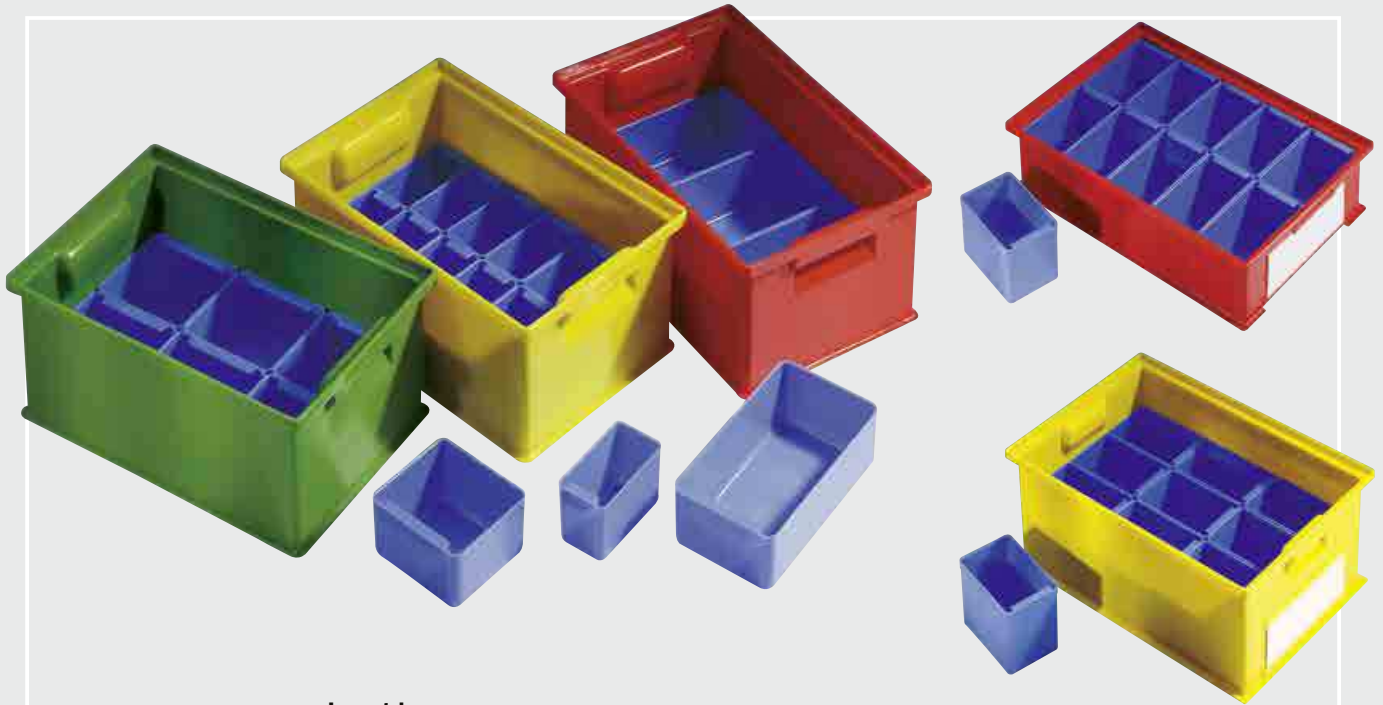

Insert boxes

Made of blue polystyrene or black, conductive PPL.

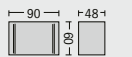
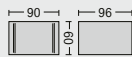
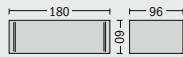

Item	for container	L x W x H (mm)	required containers	VE	Order no.
EK 1	14/6-3	180 x 96 x 60	3	58	1131 1134 —
EK 1 PPL					— — 1138
EK 2	14/6-3	90 x 96 x 60	6	80	1141 1144 —
EK 2 PPL					— — 1148
EK 3	14/6-3	90 x 48 x 60	12	120	1151 1154 —
EK 3 PPL					— — 1158
EK 111-N	14/6-2 H	137 x 87 x 96	9	48	— 4364 —
EK 111-N PPL					— — 4368
EK 111	14/6-2	137 x 87 x 110	9	48	— 22644 —
EK 111 PPL					— — 22648

Suggested partitioning with insert boxes

For 14/6-3

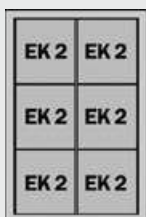

For 14/6-2 H

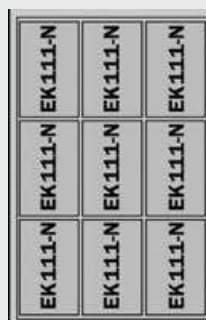

For 14/6-2



Order no. = on stock

Accessories for 14/6 range, plastic

Dust lids with finger hole

Recommended for intra-company transport of dust-sensitive articles.

Item	for containers	PU	Order no.
SD-14/6-1 PS	14/6-1	10	16006
SD-14/6-2 PS	14/6-2	10	15946
SD-14/6-3 PS	14/6-3	10	13656
SD-14/6-4 PS	14/6-4	10	13666

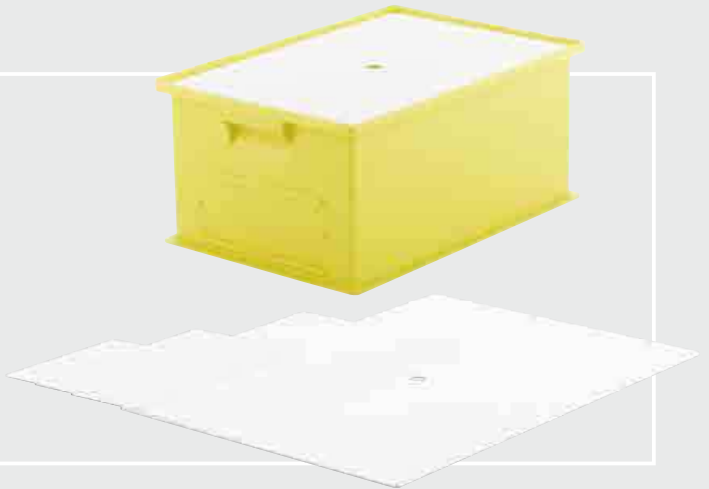
**Clip**

For accompanying documents. Keeps the accompanying documents with the goods from the order picking to the final check.

Item	Order no.
KM 14/6	15950



Plastic shelf containers for 300 mm depth

Divider _____
 Label holder for divider _____
 Label holder on shelf container _____



RK 300 Polypropylene, blue

can be divided into max. 6 compartments, 7 containers per shelf.

Item	Description (W x D x H mm)	PU	Order no.
RK 300	Shelf container (135 x 300 x 120)	25 pcs.	14714
RKE 300	Labels	100 pcs.	21700
RKF 300	Protective film	100 pcs.	21710
RKT 300	Divider	25 pcs.	14720

RK 300 HO Polypropylene, blue, with semi-open front side

can be divided into max. 6 compartments, 7 containers per shelf.

RK 300 HO	Shelf container (135 x 300 x 120)	25 pcs.	14874
RKE 300 HO	Labels	100 pcs.	21720
RKF 300 HO	Protective film	100 pcs.	21730
RKT 300	Divider	25 pcs.	14720

RK 321 Polystyrene, blue

can be divided into max. 6 compartments, 6 containers per shelf.

RK 321	Shelf container (162 x 290 x 115)	22 pcs.	1674
RKE 321	Labels for short side	100 pcs.	1720
RKF 321	Protective film	100 pcs.	1790
RKT 321	Divider	25 pcs.	1684
RKE 500 N	Labels for divider	100 pcs.	1740
RKF 500 N	Protective film	100 pcs.	1800

i Sheet steel shelf containers page **A60**

Shelf containers made of plastic for 400 mm depth

RK 400 S Polystyrene, blue

can be divided into max. 8 compartments, 10 containers per shelf.

RK 400 S	Shelf container (97 x 390 x 63)	22 pcs.	17984
RKE 400 S	Labels for short side	100 pcs.	1730
RKF 400 S	Protective film	100 pcs.	1810
RKT 400 S	Divider	25 pcs.	17994
RKE 400 S	Labels for divider	100 pcs.	1730
RKF 400 S	Protective film	100 pcs.	1810

RK 400 Polystyrene, blue

can be divided into max. 8 compartments, 6 containers per shelf.

RK 400	Shelf container (162 x 408 x 66)	20 pcs.	17904
RKE 500 N	Labels for short side	100 pcs.	1740
RKF 500 N	Protective film	100 pcs.	1800
RKT 400	Divider	25 pcs.	17914
RKE 400	Labels for divider	100 pcs.	17920
RKF 400	Protective film	100 pcs.	17930

Order no. = on stock

BLUE



- ▶ **Made of polypropylene or polystyrene**
- ▶ **Designed for SSI SCHAEFER modular shelvings**
- ▶ **Extensive range of order accessories**
labeling and partition options (advantageous for both large and small warehouses)
- ▶ **Conductive versions available on request**

Plastic shelf containers for 400/500 mm depth

RK 421 Polystyrene, blue

can be divided into max. 8 compartments, 6 containers per shelf.

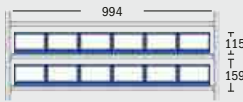

Item	Description (W x D x H mm)	PU	Order no.
RK 421	Shelf container (162 x 408 x 115)	16 pcs.	16904
RKE 321	Labels for short side	100 pcs.	1720
RKF 321	Protective film	100 pcs.	1790
RKT 5/421	Divider	25 pcs.	16924
RKE 400	Labels for divider	100 pcs.	17920
RKF 400	Protective film	100 pcs.	17930

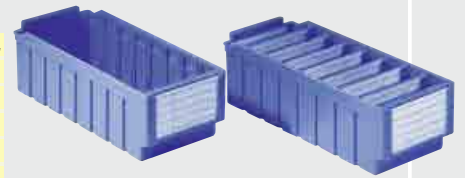

RK 421 B Polystyrene, blue

can be divided into max. 8 compartments, 4 containers per shelf.



Item	Description (W x D x H mm)	PU	Order no.
RK 421 B	Shelf container (243 x 390 x 115)	13 pcs.	1564
RKE 321	Labels for short side	100 pcs.	1720
RKF 321	Protective film	100 pcs.	1790
RKT 5/421 B	Divider	25 pcs.	1574
RKE 500 N	Labels for divider	100 pcs.	1740
RKF 500 N	Protective film	100 pcs.	1800

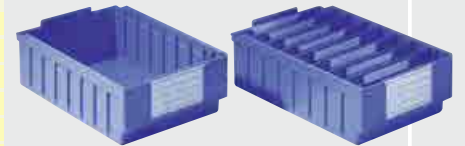

RK 500 N Polystyrene, blue

can be divided into max. 10 compartments, 6 containers per shelf.

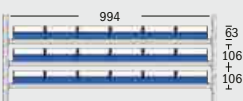

Item	Description (W x D x H mm)	PU	Order no.
RK 500 N	Shelf container (162 x 490 x 63)	40 pcs.	1584
RKE 500 N	Labels for short side	100 pcs.	1740
RKF 500 N	Protective film	100 pcs.	1800
RKT 500 N	Divider	25 pcs.	1594
RKE 500 N	Labels for divider	100 pcs.	1740
RKF 500 N	Protective film	100 pcs.	1800

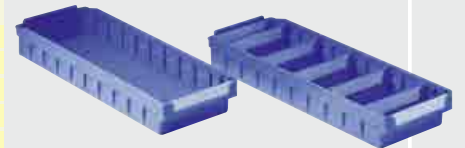

RK 521 Polystyrene, blue

can be divided into max. 10 compartments, 6 containers per shelf.

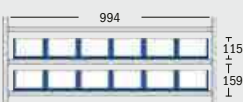

Item	Description (W x D x H mm)	PU	Order no.
RK 521	Shelf container (162 x 508 x 115)	20 pcs.	16914
RKE 321	Labels for short side	100 pcs.	1720
RKF 321	Protective film	100 pcs.	1790
RKT 5/421	Divider	25 pcs.	16924
RKE 400	Labels for divider	100 pcs.	17920
RKF 400	Protective film	100 pcs.	17930



RK 521 B Polystyrene, blue

can be divided into max. 10 compartments, 4 containers per shelf.



Item	Description (W x D x H mm)	PU	Order no.
RK 521 B	Shelf container (243 x 490 x 115)	10 pcs.	1554
RKE 321	Labels for short side	100 pcs.	1720
RKF 321	Protective film	100 pcs.	1790
RKT 5/421 B	Divider	25 pcs.	1574
RKE 500 N	Labels for divider	100 pcs.	1740
RKF 500 N	Protective film	100 pcs.	1800

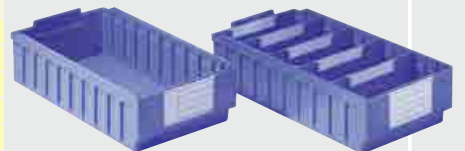

RK 522 Polypropylene, blue

can be divided into max. 4 compartments, 5 containers per shelf.

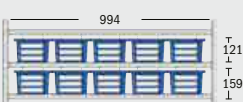

Item	Description (W x D x H mm)	PU	Order no.
RK 522 PP	Shelf container (190 x 520 x 121)	15 pcs.	1874
RKE 522 S	Labels for short side	100 pcs.	4520
RKF 522 S	Protective film	100 pcs.	4530
RKE 522 L	Labels for long side	100 pcs.	4500
RKF 522 L	Protective film	100 pcs.	4510
RKT 522 PP	Divider	25 pcs.	1880

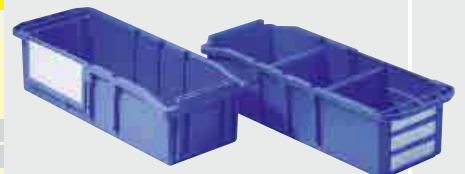

Order no. = not on stock

Boxes /
containersModular
shelvingLongspan
rackingPallet
rackingCantilever
rackingMezzanines /
platformsOn-line shelving /
KDR shelvingSemi-automated
solutionsLogistics
systems

Appendix



Plastic shelf containers for 600 mm depth

- ▶ **Made of polypropylene or polystyrene**
- ▶ **Designed for SSI SCHAEFER modular shelving**
- ▶ **Extensive range of order accessories**
labeling and partition options (advantageous for both large and small warehouses)
- ▶ **Conductive versions available on request**



RK 619-02 Polypropylene, blue

can be divided into max. 11 compartments, 8 containers per shelf.

Item	Description (W x D x H mm)	PU	Order no.
RK 619-02	Shelf container (116 x 599 x 90)	20 pcs.	20954
RKE 619	Labels for short side	100 pcs.	20910
RKF 619	Protective film	100 pcs.	20920
RKT 61	Divider	25 pcs.	21154
RKE 619	Labels for divider	100 pcs.	20910
RKF 619	Protective film	100 pcs.	20920

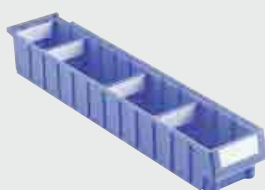
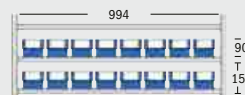

RK 619-01 Polypropylene, blue

can be divided into max. 12 compartments, 8 containers per shelf.

Item	Description (W x D x H mm)	PU	Order no.
RK 619-01	Shelf container (116 x 620 x 90)	20 pcs.	21144
RKE 619	Labels for short side	100 pcs.	20910
RKF 619	Protective film	100 pcs.	20920
RKT 61	Divider	25 pcs.	21154
RKE 619	Labels for divider	100 pcs.	20910
RKF 619	Protective film	100 pcs.	20920

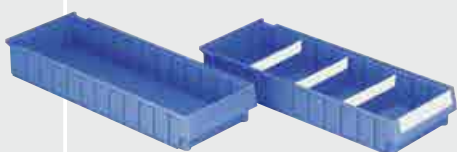
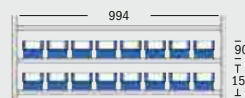

RK 629-02 Polypropylene, blue

can be divided into max. 11 compartments, 4 containers per shelf.

Item	Description (W x D x H mm)	PU	Order no.
RK 629-02	Shelf container (232 x 599 x 90)	10 pcs.	20964
RKE 629	Labels for short side	100 pcs.	20930
RKF 629	Protective film	100 pcs.	20940
RKT 62	Divider	25 pcs.	21174
RKE 629	Labels for divider	100 pcs.	20930
RKF 629	Protective film	100 pcs.	20940

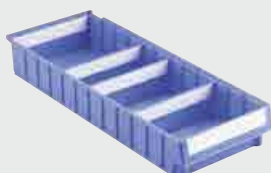
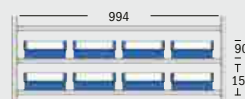

RK 629-01 Polypropylene, blue

can be divided into max. 12 compartments, 4 containers per shelf.

Item	Description (W x D x H mm)	PU	Order no.
RK 629-01	Shelf container (232 x 620 x 90)	10 pcs.	21164
RKE 629	Labels for short side	100 pcs.	20930
RKF 629	Protective film	100 pcs.	20940
RKT 62	Divider	25 pcs.	21174
RKE 629	Labels for divider	100 pcs.	20930
RKF 629	Protective film	100 pcs.	20940



RK 621 Polystyrene, blue

can be divided into max. 12 compartments, 6 containers per shelf.

Item	Description (W x D x H mm)	PU	Order no.
RK 621	Shelf container (162 x 590 x 115)	12 pcs.	1894
RKE 321	Labels for short side	100 pcs.	1720
RKF 321	Protective film	100 pcs.	1790
RKT 5/421	Divider	25 pcs.	16924
RKE 400	Labels for divider	100 pcs.	17920
RKF 400	Protective film	100 pcs.	17930

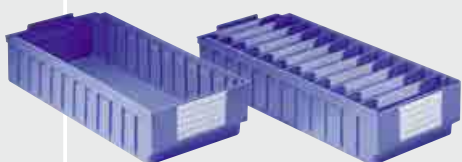
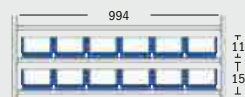

RK 621 B Polystyrene, blue

can be divided into max. 12 compartments, 4 containers per shelf.

Item	Description (W x D x H mm)	PU	Order no.
RK 621 B	Shelf container (243 x 590 x 115)	8 pcs.	1904
RKE 321	Labels for short side	100 pcs.	1720
RKF 321	Protective film	100 pcs.	1790
RKT 5/421 B	Divider	25 pcs.	1574
RKE 500 N	Labels for divider	100 pcs.	1740
RKF 500 N	Protective film	100 pcs.	1800



Order no. = on stock



Boxes /
containers

Modular
shelving

Longspan
racking

Pallet
racking

Cantilever
racking

Mezzanines /
platforms

On-line shelving /
KDR shelving

Semi-automated
solutions

Logistics
systems

Appendix

ELB range – the all-round container for every application



ELB Euro light container

SSI SCHAEFER has created an innovative high-tech product, drawing on expertise gained from unique, special applications. The result is an incredibly light, robust and, above all, low-cost general purpose container, which is differentiated by its versatility.

Developed using a new material in a new machine, the Euro light container is a high quality product suitable for a vast range of applications.

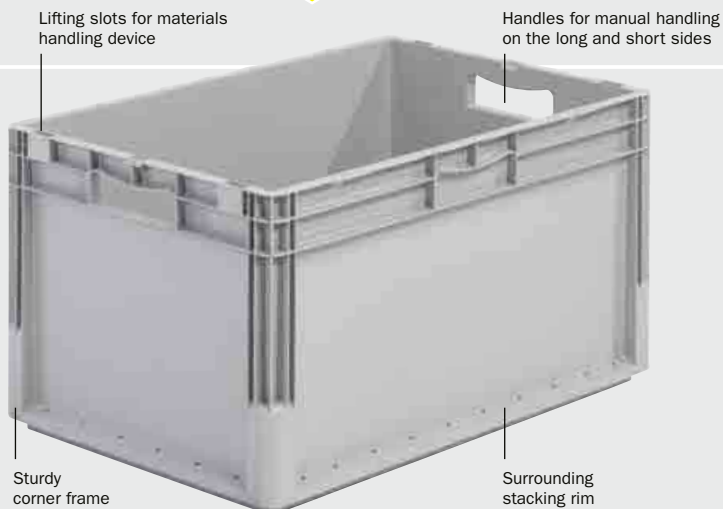

Smooth standard base for manual handling or modular shelving systems (max. content weight 20 kg)

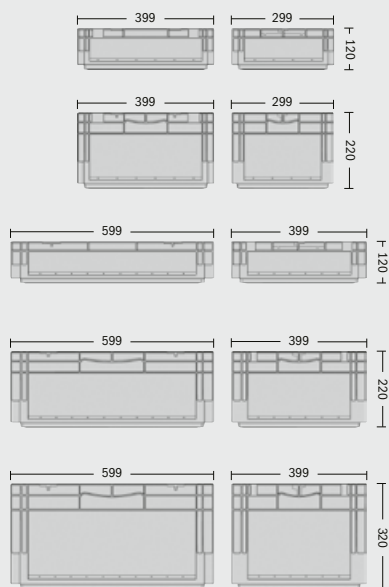

ELB Euro light container – standard design

Item	Internal dimensions (base) L x W x H (mm)	Usable internal height when stacked (mm)	Volume (liters)	Order no.
ELB 4120	356 x 256 x 115	100	10.9	56504 56505
ELB 4220	356 x 256 x 215	200	20.4	56534 56535
ELB 6120	555 x 355 x 115	100	23.3	56564 56565
ELB 6220	555 x 355 x 215	200	43.7	56594 56595
ELB 6320	555 x 355 x 314	300	64.0	56624 56625



Other container designs on request



Label holder

Fits onto the ribs of all Euro light container.

PU: 50 items

Item	Order no.
ELB-E	16020

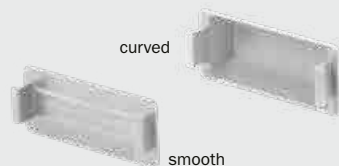

Insertable hand grips

Made of polypropylene for subsequently closing the finger holes.

PU: 50 items

Item	Type	Order no.
GV-MF	curved	39795
GV-MF 3	smooth	22385

Order no. = on stock

GRAY



Additional colors available on request

- ▶ **Polypropylene**
resistant to most oils, acidic and alkaline solutions, sound insulation effect when used on conveying sections, when used properly dimensionally stable from -20° to +100°C
- ▶ **Keeps its shape and robust**
- ▶ **Stacking**
rim with profile design
- ▶ **Ergonomic open hand grips**
on both short sides
- ▶ **Lifting slots**
for materials handling device
- ▶ **Optional reinforced base**
for reliable and safe storage using automated systems
- ▶ **Corner frame design**
for torsion-resistant construction
- ▶ **Smooth interior walls**
for easy cleaning
- ▶ **Compatible**
with all Euro dimension containers

ELB range with two-piece hinged lid and accessories

2-piece hinged lid with two interlocking parts

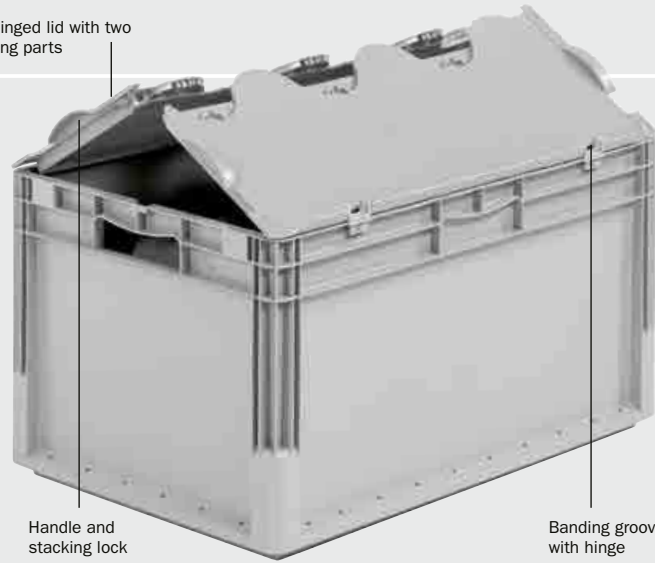

Handle and stacking lock

Banding groove with hinge

ELB Euro light container with two-part hinged lid

Item	Internal dimensions (base) L x W x H (mm)	Usable internal height when stacked (mm)	Volume (liters)	Order no.
ELB-DH 4120	356 x 256 x 115	100	10.9	56955 56005
ELB-DH 4220	356 x 256 x 215	200	20.4	56014 56015
ELB-DH 6120	555 x 355 x 115	100	23.3	56024 56025
ELB-DH 6220	555 x 355 x 215	200	43.7	56034 56035
ELB-DH 6320	555 x 355 x 314	300	64.0	56044 56045

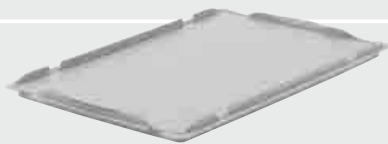
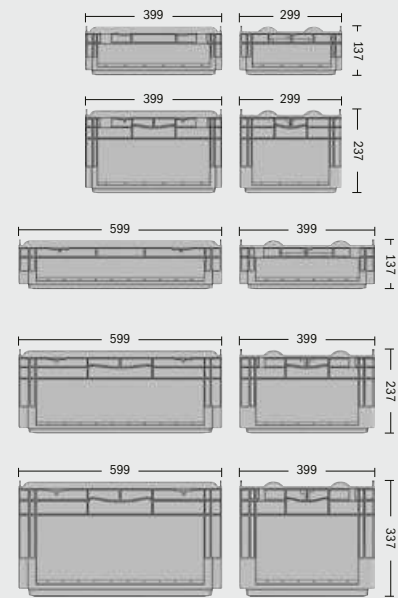

Drop-on lids

Lid clips and additional colors available on request.

Item	for basic dimensions L x W (mm)	Order no.
Lid		
LTB-D 43	400 x 300	75905
LTB-D 64	600 x 400	75915
With hinges (incl. 2 lid hinges)		
LTB-D 43 S	400 x 300	76205
LTB-D 64 S	600 x 400	76215

Order no. = not on stock



Pallet covers

For covering entire stacks of containers on a euro pallet. Designed for banding with guiding grooves on the short sides of the pallet cover.

Item	for basic dimensions L x W (mm)	Order no.
ADH 86	800 x 600	— 93628
A 1208	1,200 x 800	39704 —
A 1208-1	1,200 x 800	35614 —

Illustrations of the pallet covers A 1208-1 and ADH 86 are shown on page A20.

Boxes / containers

Modular shelving

Longspan racking

Pallet racking

Cantilever racking

Mezzanines / platforms

On-line shelving / KDR shelving

Semi-automated solutions

Logistics systems

Appendix

EF range – containers for manual and automated handling

EUROFIX containers – EF range

The EF range from SSI SCHAEFER provides cost-effective staging, transporting and storage with 25 different sizes and 150 varieties. Regardless of the application, the sturdy stacking lids guarantee safe stacking up to 600 kg.







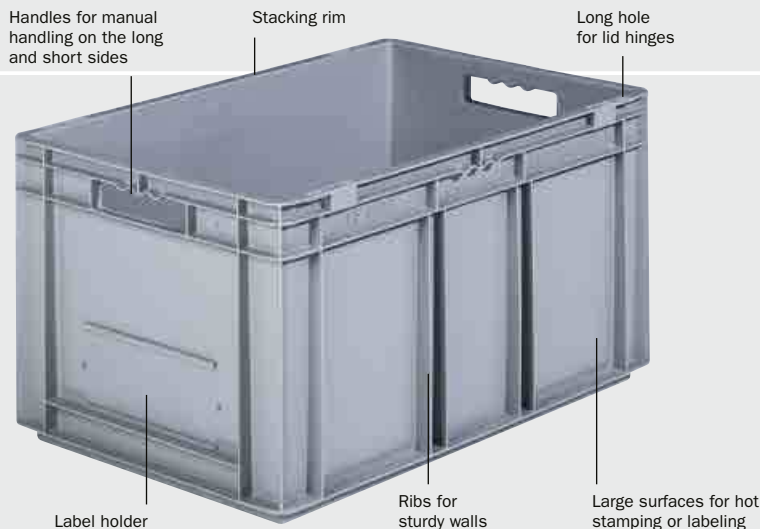
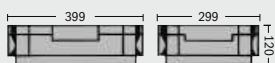
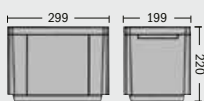
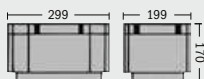
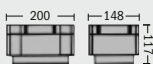





























The EF box range is also available in conductive versions and with special designs.



Smooth standard base (max. content load 20 kg)



Standard EF containers

Item	Internal dimensions of the base L x W x H (mm) when stacked	Volume (liters)	Base	Walls	Order no.	Order no.
					  	
EF 2120 PP	153 x 106 x 102	2.0			22031	22034
EF 2120 PPL					–	–
EF 3120 PP	254 x 154 x 102	4.7			22021	22024
EF 3120 PPL					–	–
EF 3170 PP	253 x 153 x 148	7.0			22261	22264
EF 3170 PPL					–	–
EF 3220 PP	253 x 153 x 197	9.0			22931	22934
EF 3220 PPL					–	–
EF 4040 PP	358 x 258 x 28	3.6			15501	15504
EF 4040 PPL					–	–
EF 4070 PP	359 x 259 x 61	6.9			21741	21744
EF 4070 PPL					–	–
EF 4080 PP	358 x 258 x 68	7.4			15511	15514
EF 4080 PPL					–	–
EF 4120 PP	356 x 256 x 105	11.1			14891	14894
EF 4120 PPL					–	–

 /  Closed

 Perforated

Order no. = on stock

RED BLUE GRAY



Additional colors available on request



► **Polypropylene**
resistant to most oils, acidic and alkaline solutions, sound insulation effect when used on conveying sections, when used properly dimensionally stable from -20° to +100°C

► **Keeps its shape and robust**

► **Smooth interior walls**
for easy cleaning

► **Strong stacking rims**
for safe stacking up to 600 kg

► **Optimum rib structure**
for safe storage and transport

► **Compatible**
with all Euro containers

► **Flexibility**
thanks to 25 sizes and more than 150 variants

► **Conductive polypropylene (PPL)**

Specific contact resistance	normal PE/PP 10 ¹⁸ Ohm x cm <	PPL 10 ⁹ Ohm x cm
Specific surface resistance	10 ¹⁴ Ohm	10⁴ Ohm

PPL BLACK



EF range – standard



Other container designs

on request



Standard EF containers

Item	Internal dimensions of the base L x W x H (mm) when stacked	Volume (liters)	Base	Walls	Order no.			Order no.
EF 4140 PP	354 x 254 x 117	12.8			22271	22274	22275	–
EF 4140 PPL					–	–	–	22278
EF 4170 PP	354 x 254 x 147	15.7			22161	22164	22165	–
EF 4170 PPL					–	–	–	22168
EF 4220 PP	355 x 255 x 197	20.4			14951	14954	14955	–
EF 4220 PPL					–	–	–	14958
EF 4221 PP					14961	–	14965	
EF 4223 PP	355 x 255 x 194	19.9			14971	–	14975	
EF 4320 PP	354 x 253 x 306	29.7			14741	14744	14745	–
EF 4320 PPL					–	–	–	14748

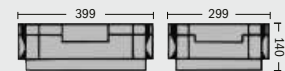

/ Closed Perforated



Hand grip**



Open hand grip**



Overhang hand grip**



Hand grip with overhang hand grip**

** Not always in stock. Please inquire.

Boxes / containers

Modular shelving

Longspan racking

Pallet racking

Cantilever racking

Mezzanines / platforms

On-line shelving / KDR shelving

Semi-automated solutions

Logistics systems

Appendix

i

RED BLUE GRAY PPL BLACK

Additional colors available on request



EF series – standard (continued) and EF series – special

Standard EF containers

Item	Internal dimensions of the base L x W x H (mm) when stacked	Volume (liters)	Base	Walls	Order no.			Order no.
 EF 6070 PP	553 x 353 x 60	14.3			22041	22044	22045	–
EF 6070 PPL					–	–	–	22048
 EF 6120 PP	553 x 353 x 97	23.3			92281	970309	92285	–
EF 6120 PPL					–	–	–	92288
 EF 6140 PP	553 x 353 x 117	27.4			22231	22234	22235	–
EF 6140 PPL					–	–	–	22238
 EF 6150 PP	553 x 353 x 127	29.4			21951	21954	21955	–
EF 6150 PPL					–	–	–	21958
 EF 6170 PP	559 x 359 x 151	34.2			15371	15374	15375	–
EF 6170 PPL					–	–	–	15378
 EF 6180 PP	553 x 353 x 156	35.4			15661	15664	15665	–
EF 6180 PPL					–	–	–	15668
EF 6181 PP					–	–	22055	–
 EF 6220 PP	553 x 353 x 196	43.5			14851	14854	14855	–
EF 6220 PPL					–	–	–	14858
EF 6221 PP					16091	–	16095	–
 EF 6240 PP	553 x 353 x 216	47.5			22091	22094	22095	–
EF 6240 PPL					–	–	–	22098
 EF 6280 PP	553 x 353 x 261	56.6			21921	21924	21925	–
EF 6280 PPL					–	–	–	21928
 EF 6320 PP	553 x 353 x 296	63.7			14831	14834	14835	–
EF 6320 PPL					–	–	–	14838
EF 6321 PP					16071	–	16075	–
 EF 6420 PP	553 x 353 x 396	83.8			14921	14924	14925	–
EF 6420 PPL					–	–	–	14928
EF 6421 PP					–	–	14935	–

Special EF containers – Base dimensions of 400 x 300 mm

Item	Finish	Interior dim. when stacked L x W x H (mm)	Volume (liters)	Base	Walls	Order no.
 EF 4220 F1	One front side open at the top semi-open, with bevelled hand grip	355 x 255 x 197	20.4			92251 92255

/ Closed Perforated **Order no.** = on stock

Special EF containers with order picking opening and accessories

EUROFIX container EF 6220 D11

With semi-open front side.
Material: Polypropylene. Color: blue.
External dimensions: L 599 x W 399 x H 220 mm.
With front side opening: W 278 x H 110 mm.

Dust cover EF-SK 64102

Made of transparent plastic.

Item	Order no.
EF 6220 D11	93904
EF-SK 64102	93930

Minimum order quantity for special EF boxes with dust flap

EUROFIX container EF 6320 B11

With semi-open front side.
Material: Polypropylene. Color: blue.
External dimensions: L 599 x W 399 x H 320 mm.
With front side opening: W 278 x H 160 mm.

Dust cover EF-SK 64152

Made of transparent plastic.

Item	Order no.
EF 6320 B11	93894
EF-SK 64152	93920

Minimum order quantity for special EF boxes with dust flap

EUROFIX container EF 6420 A14

With semi-open front side.
Material: polypropylene. Color: blue.
External dimensions: L 599 x W 399 x H 420 mm.
With front side opening: W 278 x H 210 mm.

Dust cover EF-SK 64202

Made of transparent plastic.

Item	Order no.
EF 6420 A14	93884
EF-SK 64202	93910

Minimum order quantity for special EF boxes with dust flap



Insertable hand grips

Made of polypropylene for subsequently closing the finger holes.

PU: 50 items

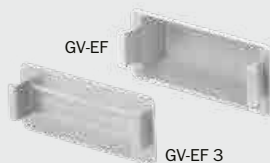

Item	Order no.
GV-EF	22081 22085
GV-EF 3	22301 22325

Order no. = not on stock



Label holder

Fits onto the ribs of all EUROFIX containers.

PU: 50 items



Item	Order no.
EF-E	16010





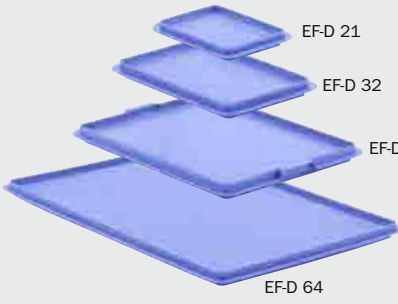

Accessories for standard EF containers



Lids

Available in red, blue or gray for all EUROFIX containers. Slits in the long sides of the lid make all boxes crimp-sealable and lockable. Material: Polypropylene.

Item	for basic dimensions (mm)	Order no.			Item	Order no.
						
EF-D 21	200 x 150	21791	21794	21795	EF-D 21 PPL	21798
EF-D 32	300 x 200	22281	22284	22285	EF-D 32 PPL	22288
EF-D 43	400 x 300	15031	15034	15035	EF-D 43 PPL	15038
EF-D 64	600 x 400	15041	15044	15045	EF-D 64 PPL	15048





Lid with hooks



Lid clips (on request)

Lids with cast hooks or hinges

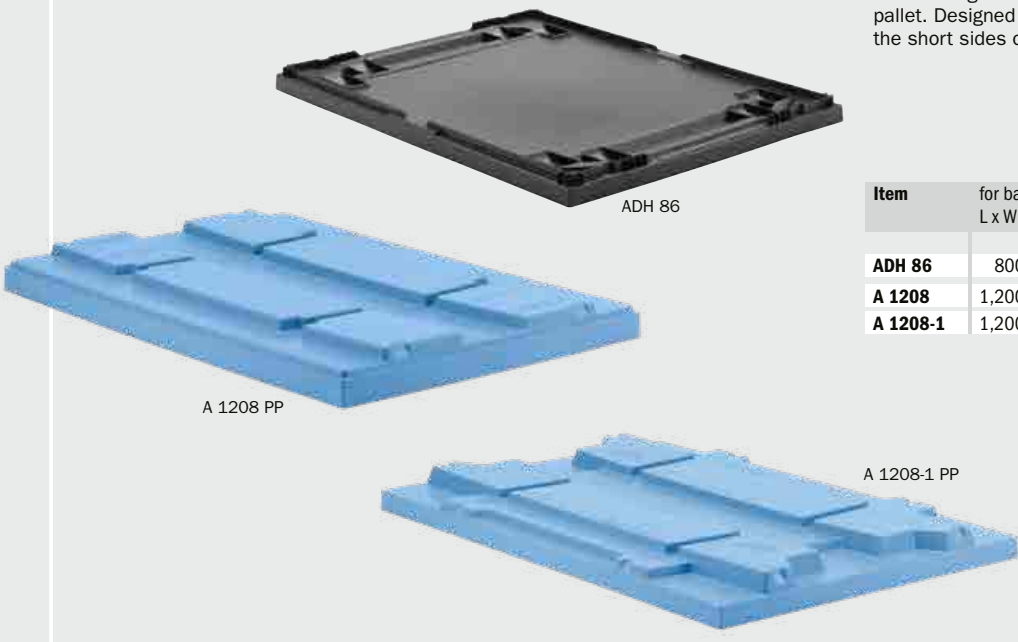

The lids with cast hooks is removable while the rotating and opening movement remains guided. Lid clips on request.

Item	for basic dimensions (mm)	Order no.			Item	Order no.
						
With hooks (clips on request)						
EF-D 21-H	200 x 150	39911	39914	39915	EF-D 21-H PPL	39918
EF-D 32-H	300 x 200	39921	39924	39925	EF-D 32-H PPL	39928
EF-D 43-H	400 x 300	39931	39934	39935	EF-D 43-H PPL	39938
EF-D 64-H	600 x 400	39941	39944	39945	EF-D 64-H PPL	39948
With hinges						
EF-D 21-S	200 x 150	21001	21004	21005	EF-D 21-S PPL	21008
EF-D 32-S	300 x 200	21021	21024	21025	EF-D 32-S PPL	21028
EF-D 43-S	400 x 300	21041	21044	21045	EF-D 43-S PPL	21048
EF-D 64-S	600 x 400	21081	21084	21085	EF-D 64-S PPL	21088



Pallet covers

For covering entire stacks of containers on a euro pallet. Designed for banding with guiding grooves on the short sides of the pallet cover.

Item	for basic dimensions L x W (mm)	Order no.	
			
ADH 86	800 x 600	–	93628
A 1208	1,200 x 800	39704	–
A 1208-1	1,200 x 800	35614	–

Order no. = on stock

Accessories for standard EF containers

Roll-Fix

LTS tray with 4 swivel castors (Ø 80 mm).

Closed platform made of polypropylene with 15 mm high stacking rim.

Suitable for EF containers 600 x 400 mm.

Load capacity: 200 kg.





Roll-Fix RO 460



Roll-Fix RO 461



Roll-Fix RO 463

Item	L x W x H (mm)	Type	Order no.		
					
RO 460	594 x 396 x 150	with plastic castors	22201	22205	–
RO 461	594 x 396 x 150	with solid rubber castors	22211	22215	–
RO 463 PPL	594 x 396 x 150	with conductive castors	–	–	22190

Dolly

For transporting EF containers.

Suitable for transport with forklifts.

Max. stacking height on the pallet 1.80 m.

2 swivel castors and 2 rigid castors (Ø 125 mm). Ground clearance: 115 mm. Max. load 450 kg. Can be stacked securely on top of each other. Height when stacked 130 mm. Color: black.



Item	W x D x H (mm)	Order no.
RLP 86	800 x 600 x 200	93608



MF range – the professional solution for automated warehousing and production

MF multi-functional container range

The MF multi-functional container range is the ideal solution for all automated warehousing. They are perfect for production tasks or during reusable packaging for external goods transport. The series also features a double base for optimum conveying with high loads, comb-shaped ribs for perfect contact with all conveying sections and the open-rib tunnel underneath the running edge to prevent scooped areas.



Standard base for problem-free and safe storage using ASPW systems (max. content load 30 kg)

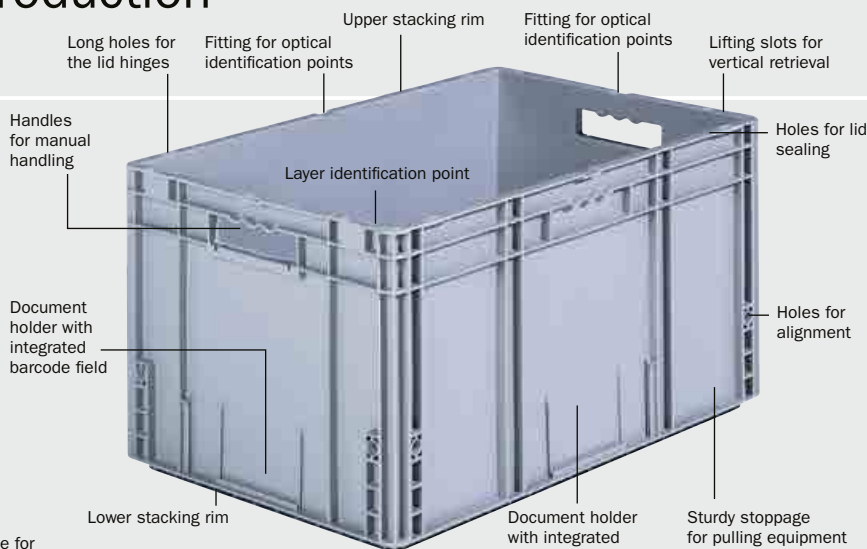

Long holes for the lid hinges
Handles for manual handling
Document holder with integrated barcode field

Fitting for optical identification points
Upper stacking rim
Layer identification point

Fitting for optical identification points

Lifting slots for vertical retrieval

Holes for lid sealing

Holes for alignment



Lower stacking rim

Document holder with integrated barcode field

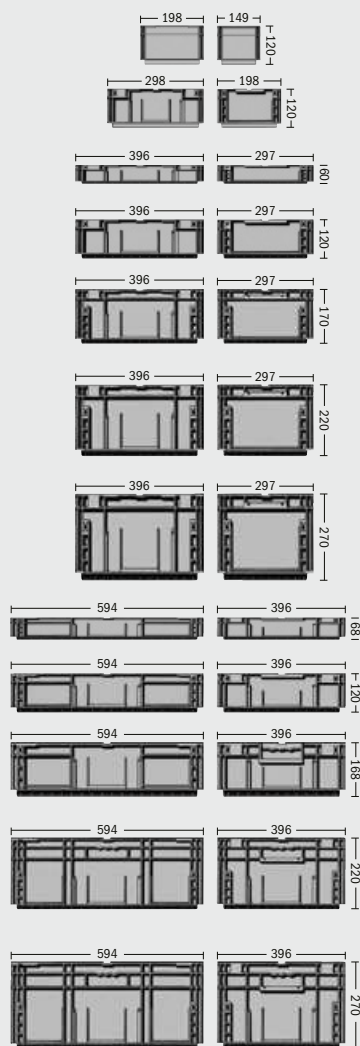
Sturdy stoppage for pulling equipment



MF containers

Item	Internal dimensions of the base L x W x H (mm) when stacked	Volume (liters)	Order no.		Order no.
					
MF 2120	160 x 111 x 103	2.0	39044	39045	–
MF 2120 PPL			–	–	39048
MF 3120	267 x 168 x 102	5.2	39304	39305	–
MF 3120 PPL			–	–	39308
MF 4060	366 x 267 x 27	4.1	38734	38735	–
MF 4060 PPL			–	–	38738
MF 4120	360 x 261 x 87	10.0	39314	39315	–
MF 4120 PPL			–	–	39318
MF 4170	366 x 267 x 137	14.6	39324	39325	–
MF 4170 PPL			–	–	39328
MF 4220	366 x 267 x 187	19.7	39334	39335	–
MF 4220 PPL			–	–	39338
MF 4270	366 x 267 x 237	24.3	39494	39495	–
MF 4270 PPL			–	–	39498
MF 6070	564 x 366 x 34	10.2	39344	39345	–
MF 6070 PPL			–	–	39348
MF 6120	564 x 366 x 87	21.0	970088	970090	–
MF 6120 PPL			–	–	970091
MF 6170	564 x 366 x 135	30.8	39364	39365	–
MF 6170 PPL			–	–	39368
MF 6220	564 x 366 x 187	41.6	39374	39375	–
MF 6220 PPL			–	–	39378
MF 6270	564 x 366 x 237	52.0	39384	39385	–
MF 6270 PPL			–	–	39388

Order no. = on stock

Order no. = not on stock

MF range



- Polypropylene**
resistant to most oils, acidic and alkaline solutions, sound insulation effect when used on conveying sections, when used properly dimensionally stable from -20° to +100°C
- Keeps its shape and robust**
- Base surround**
for smooth quiet-running conveying
- Reinforced base**
for reliable and safe storage using ASPW systems
- Compatible**
with all Euro dimension containers
- Optimum rib structure**
for safe storage and transport
- Smooth interior walls**
for easy cleaning
- High content loads**
- Optional drainage holes in the base**
as per the VDS directive for HHS3 classification

	normal PE/PP	PPL
Specific contact resistance	10 ¹⁸ Ohm x cm <	10 ⁹ Ohm x cm
Specific surface resistance	10 ¹⁴ Ohm	10 ⁴ Ohm

Other container designs
on request



Insertable hand grips

Made of polypropylene for subsequently closing the finger holes.
PU: 50 items

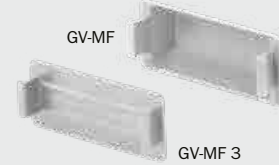

Item	Order no.	Order no.
GV-MF	39794	39795
GV-MF 3	22374	22385

MF containers

Item	Internal dimensions of the base L x W x H (mm) when stacked	Volume (liters)	Order no.	Order no.	Order no.
MF 6320	564 x 366 x 287	62.3	39394	39395	—
MF 6320 PPL			—	—	39398
MF 6420	564 x 366 x 387	82.9	39404	39405	—
MF 6420 PPL			—	—	39408

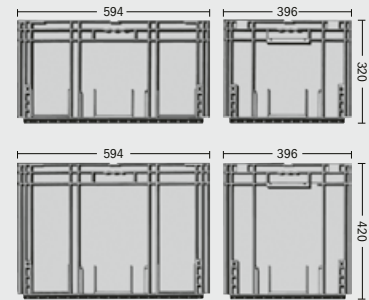

Insert boxes and suggested partitioning
on pages A29 – A31

Lid

Dustproof closing. Sealable. Can also be stacked safely with a lid. Lifting slots for automated handling. *) Design with the surrounding banding groove in the middle.

Two securing rings for the hinges and two clips to fasten the cover are included with the lid with cast hinges.



Item	for basic dimensions L x W (mm)	Order no.	Order no.	Item	Order no.
Auflagedeckel					
MF-D 32	300 x 200	39464	39465	MF-D 32 PPL	39468
MF-D 43	400 x 300	39714	39715	MF-D 43 PPL	39718
MF-D 64*	600 x 400	39744	39745	MF-D 64 PPL	39748
With hooks (lid clips on request)					
MF-D 32 H	300 x 200	39854	39855	MF-D 32 H PPL	39858
MF-D 43 H*	400 x 300	39724	39725	MF-D 43 H PPL	39728
MF-D 64 H*	600 x 400	39754	39755	MF-D 64 H PPL	39758
With hinges (lid clips on request)					
MF-D 32 S	300 x 200	39474	39475	MF-D 32 S PPL	39478
MF-D 43 S*	400 x 300	39864	39865	MF-D 43 S PPL	39868
MF-D 64 S*	600 x 400	39874	39875	MF-D 64 S PPL	39878
Pallet cover					
A 1208	1,200 x 800	39704	—	—	—
A 1208-1**	1,200 x 800	35614	—	—	—

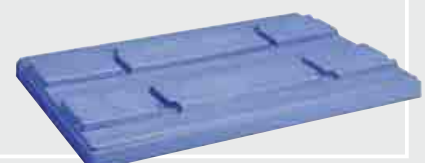

** Figure see page A25



LTB range – light and strong for transport and storage

LTB containers for warehousing and transportation

The LTB from SSI SCHAEFER provides especially high volume usage, reinforced top and bottom edges together with four sturdy corner supports.

Specially designed base variants guarantee that it can move along conveying sections without any difficulty. These characteristics ensure high torsion resistance and safe stacking. Its very low empty weight together with the reinforced standard base make it suitable for content weighing up to 50 kg. The variant with vibration-welded base (VS01) is suitable for content weighing up to 70 kg.

In addition to the open standard variant, the LTB is also available with single or piece hinged lid or a separate lid. When using these separate lid or the hinged lid, the LTB can be shipped and remains suitable for automated stacking and safe storage using ASPW systems or modular shelvings.

The LTB containers for warehousing and transportation from SSI SCHAEFER could be incremental in creating consistently automated material flow.

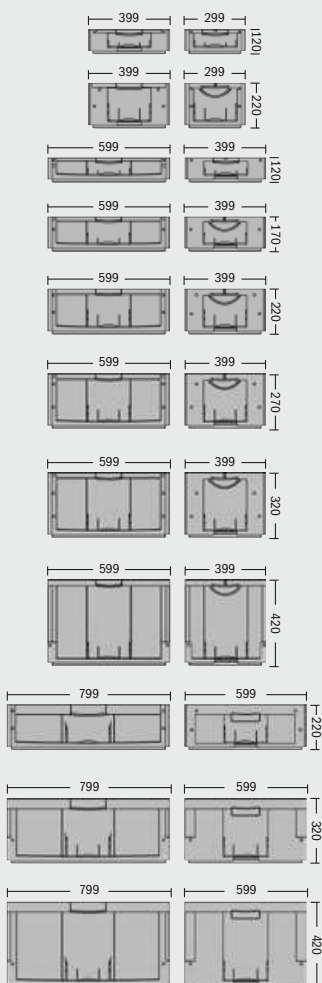
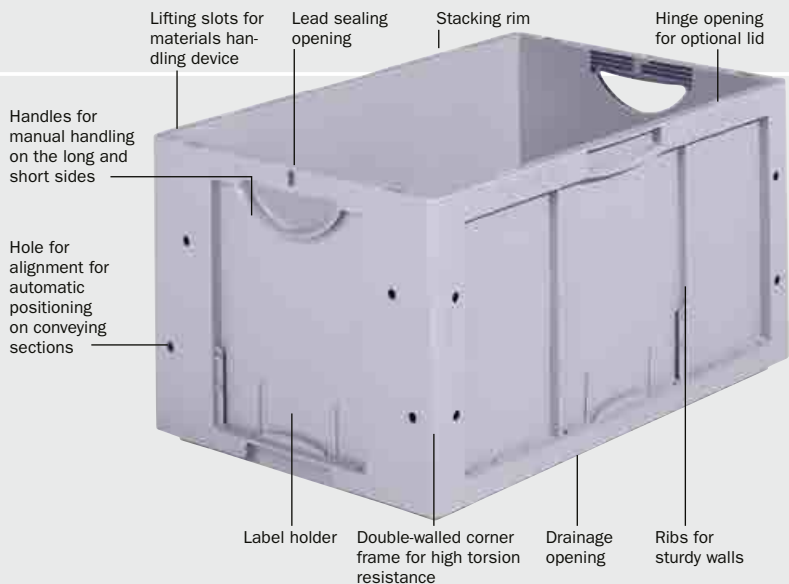

LTB containers for warehousing and transportation – standard design

Item	Internal dimensions (base) L x W x H (mm)	Usable internal height when stacked (mm)	Volume (liters)	Base	Order no.
LTB 4120	366 x 266 x 103	88	10.0		75704 75705
LTB 4220	366 x 266 x 203	188	19.8		75744 75745
LTB 6120	566 x 366 x 98	83	20.3		75784 75785
LTB 6170	566 x 366 x 148	133	30.7		75804 75805
LTB 6220	566 x 366 x 198	183	41.0		75824 75825
LTB 6270	566 x 366 x 248	233	51.4		75844 75845
LTB 6320	566 x 366 x 298	283	61.7		75864 75865
LTB 6420	566 x 366 x 398	383	82.3		86064 86065
LTB 8220 VS05	755 x 555 x 197	177	84.5	VS	76024 76025
LTB 8320 GL	752 x 552 x 317	297	135.0	GL	76244 76245
LTB 8320 VS05	755 x 555 x 297	277	125.0	VS	76284 76285
LTB 8420 VS05	755 x 555 x 397	377	165.0	VS	76294 76295

GL GL version with smooth base (max. load 25 kg)

VS Vibration-welded base (VS01/VS05 base)

Order no. = on stock

Order no. = not on stock

BLUE GRAY



Additional colors available on request

- ▶ **Polypropylene**
resistant to most oils, acidic and alkaline solutions, sound insulation effect when used on conveying sections, when used properly dimensionally stable from -20° to +100°C
- ▶ **Keeps its shape and robust**
- ▶ **Reinforced base**
for reliable and safe storage using ASPW systems
- ▶ **Double-walled corner frame design**
for high torsion resistance with high stacking loads
- ▶ **Smooth interior walls**
for easy cleaning
- ▶ **Various handle versions**
- ▶ **Optional drainage holes in the base**
as per the VDS directive for HHS3 classification
- ▶ **Compatible**
with all Euro dimension containers
- ▶ **Conductive models**
available on request

Separate lids and pallet covers for the LTB range

i Other container designs on request



Lid

Item	for containers with basic dimensions L x W (mm)	Incl. the following accessories	Order no.	
Lid (lid clips on request)				
LTB-D 43	400 x 300		75904	75905
LTB-D 64	600 x 400		75914	75915
With hinges (lid clips on request)				
LTB-D 43 S	400 x 300	2 lid hinges	76204	76205
LTB-D 64 S	600 x 400	2 lid hinges	76214	76215



Pallet covers

For covering entire stacks of containers on a euro pallet. Designed for banding with guiding grooves on the short sides of the pallet cover.

Item	for basic dimensions L x W (mm)	Order no.
A 1208	1,200 x 800	39704
A 1208-1	1,200 x 800	35614

A 1208 PP

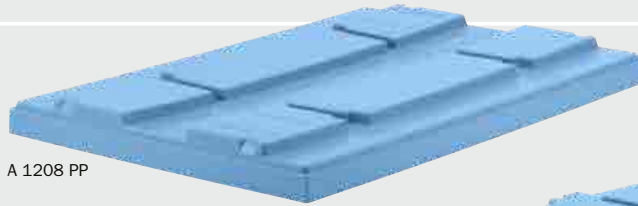

A 1208-1 PP

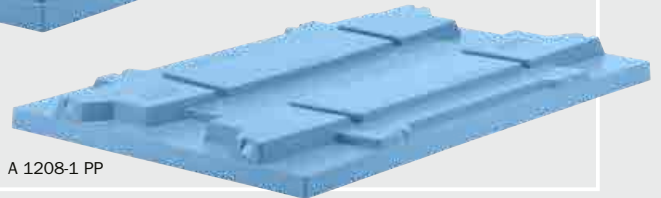

Boxes / containers

Modular shelving

Longspan racking

Pallet racking

Cantilever racking

Mezzanines / platforms

On-line shelving / KDR shelving

Semi-automated solutions

Logistics systems

Appendix

LTF range – containers for automated warehousing

LTF range containers

The various base designs of the storage and transport fix range containers (LTF) enable content loads of up to 70 kg depending on the specific version.

Vertical sidewalls ensure that the internal dimensions are optimally usable. With their special corner frame design, they are capable of handling high stacking loads and are also easy to clean.

The containers also feature VDA label slots, adhesive surfaces for barcodes, vertical lifting slots and holes for alignment as well as transponder retaining elements. Further options also include drainage holes in the base as per the VDS directive for the HHS 3 classification and diverse handle versions.

The LTF is compatible with VDA system elements (e.g. A 1208, see KLT).

Long hole for lid hinge, compatible with the MF range

Lid sealing holes, compatible with the MF range

Lifting slots for vertical retrieval, compatible with the MF range

Double-walled corner frame for high stacking loads

Retaining element for label securing wire (short/long sides)

Retaining option for check card transponder (short/long sides)

Sturdy structure for pulling equipment (short/long sides), rounded corners, advantageous for conveying sections

Large adhesive or hot stamping surfaces

Holes for alignment

Label holder with integrated barcode adhesive strip (short/long sides)



Standard base (max. content load 30 kg)

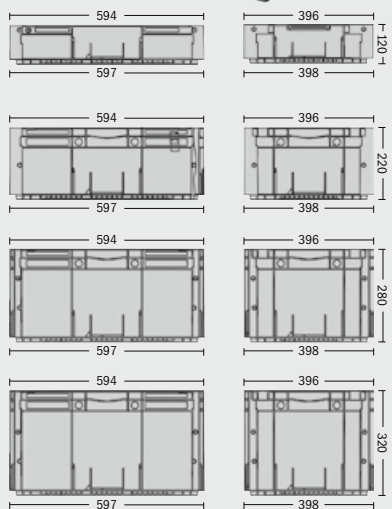

LTF containers

Item	Internal dimensions of the base L x W x Usable H (mm)	Volume (liters)	Order no.
LTF 6120	564 x 366 x 87	21.0	35764 35765
LTF 6220	564 x 366 x 187	42.0	35724 35725
LTF 6280	564 x 366 x 247	53.8	35704 35705
LTF 6320 LTF 6320 PPR*	564 x 366 x 287	62.7	35734 35735 - 591216

* from recycled material

Insertable hand grips

Made of polypropylene for subsequently closing the finger holes.
PU: 50 items

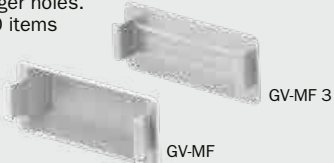

Item	Type	Order no.
GV-MF	curved	39794 39795
GV-MF 3	smooth	22374 22385

Label holder



Item	Order no.
LTF-E	16020

Order no. = on stock

BLUE GRAY PPR



Additional colors available on request

- ▶ **Polypropylene**
resistant to most oils, acidic and alkaline solutions, sound insulation effect when used on conveying sections, when used properly dimensionally stable from -20° to +100°C
- ▶ **The Blue Angel**
for high quality PPR from top suppliers, **only LTF 6320 PPR**
- ▶ **Keeps its shape and robust**
- ▶ **Base surround**
for smooth quiet-running conveying
- ▶ **Reinforced base**
for reliable and safe storage using ASPW systems
- ▶ **Double-walled corner frame design**
for high stacking loads
- ▶ **Smooth interior walls**
for easy cleaning
- ▶ **Various handle versions**
- ▶ **Optional drainage holes in the base**
as per the VDS directive for HHS3 classification
- ▶ **Compatible with all Euro dimension containers**
- ▶ **Conductive models**
available on request

Lid and pallet covers



Other special designs

on request



Lid

Dustproof closing. Sealable LTF containers can also be stacked safely with lids. Lifting slots for automated handling. *) Design with the surrounding banding groove in the middle.

Item	Type	Order no.	
MF-D 64*	Lid	39744	39745
MF-D 64 H*	with hooks (lid clips on request)	39754	39755
MF-D 64 S*	with hinge (lid clips on request)	39874	39875



Pallet covers

For covering entire stacks of containers on a euro pallet. Designed for banding with guiding grooves on the short sides of the pallet cover.

A 1208 PP

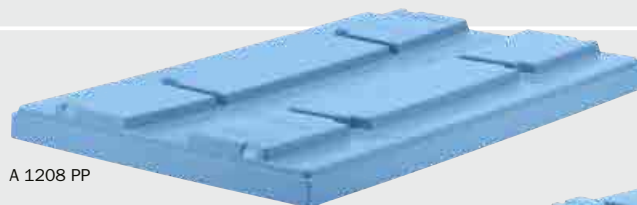

A 1208-1 PP

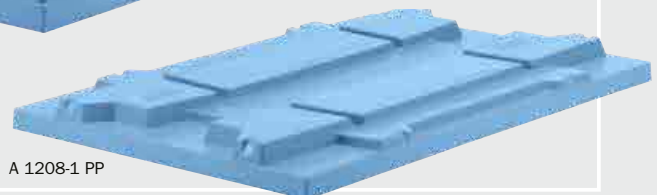

Item	for basic dimensions L x W (mm)	Order no.
A 1208	1,200 x 800	39704
A 1208-1	1,200 x 800	35614



Boxes / containers

Modular shelving

Longspan racking

Pallet racking

Cantilever racking

Mezzanines / platforms

On-line shelving / KDR shelving

Semi-automated solutions

Logistics systems

Appendix

Insert boxes – to control the chaos

Without insert boxes the storage areas and workshops in many companies descend into unending chaos. They are the ideal solution for organizing and safely storing numerous small parts. SSI SCHAEFER's insert boxes more than just a means of creating order in boxes, drawers and containers. They are also essential for making the very best use of the space available in carriers and containers.

Furthermore, these flexible insert boxes are also incredibly rugged. Available in innumerable designs, they are resistant to most oils, acidic and alkaline solutions while their smooth inner walls also make them easy to clean. They eliminate the need to search for items as everything is where it is supposed to be.



BLUE PPL BLACK



- ▶ **Polypropylene**
resistant to most oils, acidic and alkaline solutions, when used properly dimensionally stable from -20° to +100°C
- ▶ **4 sizes can be combined**
with Euro containers with **300 x 200, 400 x 300 and 600 x 400 mm bases**
- ▶ **Keeps its shape and robust**
- ▶ **Smooth interior walls**
for easy cleaning
- ▶ **Drainage holes**
in the insert boxes for automated storage on request

Insert boxes for EF, MF range Euro containers



EK 4081

EK 4021

EK 3021

EK 4041



Container 300 x 200 mm
Insert box H (mm) Divider
EK 3021 80 1/2 transverse



Container 400 x 300 mm
Insert box H (mm) Divider
EK 4021 80 1/2 transverse



Container 400 x 300 mm
Insert box H (mm) Divider
EK 4041 80 1/4



Container 400 x 300 mm
Insert box H (mm) Divider
EK 4081 80 1/8



Container 400 x 300 mm
Insert box Height (mm)
4 x EK 4081 80
2 x EK 4041 80



Container 400 x 300 mm
Insert box Height (mm)
4 x EK 4081 80
1 x EK 4021 80

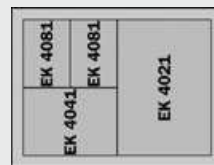

Container 400 x 300 mm
Insert box Height (mm)
2 x EK 4081 80
1 x EK 4041 80
1 x EK 4021 80



Container 400 x 300 mm
Insert box Height (mm)
2 x EK 4041 80
1 x EK 4021 80

Insert boxes for Euro containers with 300 x 200/400 x 300 mm bases

Item	for containers (mm)	Dimensions L x W x H (mm)	PU	Order no.
EK 3021	300 x 200	157 x 127 x 80	84	1184 -
EK 3021 PPL				- 1188
EK 4021	400 x 300	258 x 179 x 80	36	1914 -
EK 4021 PPL				- 1918
EK 4041	400 x 300	179 x 129 x 80	48	1924 -
EK 4041 PPL				- 1928
EK 4081	400 x 300	129 x 90 x 80	64	1934 -
EK 4081 PPL				- 1938

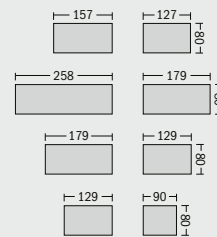

Order no. = on stock

Boxes / containers

Modular shelving

Longspan racking

Pallet racking

Cantilever racking

Mezzanines / platforms

On-line shelving / KDR shelving

Semi-automated solutions

Logistics systems

Appendix

BLUE **PPL BLACK**

▶ Polypropylene
resistant to most oils, acidic and alkaline solutions, when used properly dimensionally stable from -20° to +100°C

▶ 6 sizes can be combined
with Euro containers with **600 x 400 mm base**

▶ Smooth interior walls
for easy cleaning

▶ Drainage holes
in the insert boxes for automated storage on request

Insert boxes for EF, MF and LTF range Euro containers



EK 6161	EK 6161	EK 6161	EK 6161
EK 6161	EK 6161	EK 6161	EK 6161
EK 6161	EK 6161	EK 6161	EK 6161
EK 6161	EK 6161	EK 6161	EK 6161

Container 600 x 400 mm		
Insert box	H (mm)	Divider
EK 6161	80	1/16

EK 6081	EK 6082	EK 6081	EK 6082	EK 6081	EK 6082	EK 6081	EK 6082
EK 6081	EK 6082	EK 6081	EK 6082	EK 6081	EK 6082	EK 6081	EK 6082
EK 6081	EK 6082	EK 6081	EK 6082	EK 6081	EK 6082	EK 6081	EK 6082
EK 6081	EK 6082	EK 6081	EK 6082	EK 6081	EK 6082	EK 6081	EK 6082

Container 600 x 400 mm		
Insert box	H (mm)	Divider
EK 6081	80	1/8
EK 6082	150	1/8

EK 6041L	EK 6041L	EK 6041L	EK 6041L
EK 6041L	EK 6041L	EK 6041L	EK 6041L
EK 6041L	EK 6041L	EK 6041L	EK 6041L
EK 6041L	EK 6041L	EK 6041L	EK 6041L

Container 600 x 400 mm		
Insert box	H (mm)	Divider
EK 6041 L	80	1/4 longitudinal

EK 6041	EK 6042	EK 6041	EK 6042
EK 6041	EK 6042	EK 6041	EK 6042
EK 6041	EK 6042	EK 6041	EK 6042
EK 6041	EK 6042	EK 6041	EK 6042

Container 600 x 400 mm		
Insert box	H (mm)	Divider
EK 6041	80	1/4
EK 6042	150	1/4

EK 6021	EK 6022L	EK 6021	EK 6022L
EK 6021	EK 6022L	EK 6021	EK 6022L
EK 6021	EK 6022L	EK 6021	EK 6022L
EK 6021	EK 6022L	EK 6021	EK 6022L

Container 600 x 400 mm		
Insert box	H (mm)	Divider
EK 6021	80	1/2 longitudinal
EK 6022 L	150	1/2 longitudinal

EK 6021Q	EK 6022Q	EK 6021Q	EK 6022Q
EK 6021Q	EK 6022Q	EK 6021Q	EK 6022Q
EK 6021Q	EK 6022Q	EK 6021Q	EK 6022Q
EK 6021Q	EK 6022Q	EK 6021Q	EK 6022Q

Container 600 x 400 mm		
Insert box	H (mm)	Divider
EK 6021 Q	80	1/2 transverse
EK 6022 Q	150	1/2 transverse

EK 6081	EK 6081	EK 6081	EK 6081
EK 6161	EK 6161	EK 6161	EK 6161
EK 6161	EK 6161	EK 6161	EK 6161
EK 6161	EK 6161	EK 6161	EK 6161

Container 600 x 400 mm		
Insert box	Height (mm)	
4 x EK 6081	80	
8 x EK 6161	80	

EK 6041	EK 6081	EK 6081
EK 6041	EK 6161	EK 6161
EK 6041	EK 6161	EK 6161
EK 6041	EK 6161	EK 6161

Container 600 x 400 mm		
Insert box	Height (mm)	
2 x EK 6041	80	
2 x EK 6081	80	
4 x EK 6161	80	

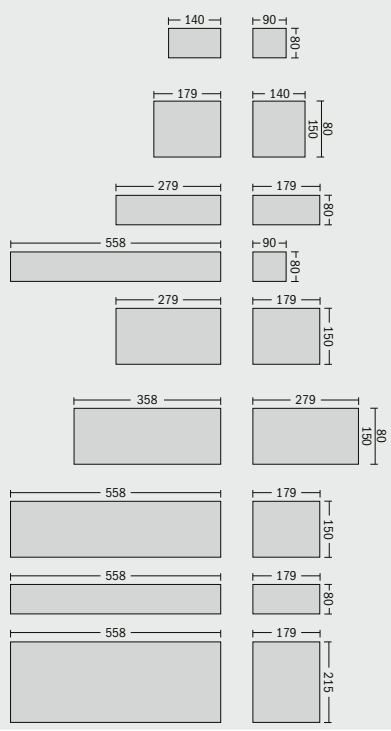

Insert boxes for Euro containers with 600 x 400 mm base

Item	for containers (mm)	Dimensions L x W x H (mm)	PU	Order no.		
EK 6161	600 x 400	140 x 90 x 80	84	4764	–	–
EK 6161 PPL	600 x 400	140 x 90 x 80	–	–	4768	–
EK 6081	600 x 400	179 x 140 x 80	48	4754	–	–
EK 6081 PPL	600 x 400	179 x 140 x 80	–	–	4758	–
EK 6082	600 x 400	179 x 140 x 150	32	79354	–	–
EK 6082 PPL	600 x 400	179 x 140 x 150	–	–	79358	–
EK 6041	600 x 400	279 x 179 x 80	36	4734	–	–
EK 6041 PPL	600 x 400	279 x 179 x 80	–	–	4738	–
EK 6041 L	600 x 400	558 x 90 x 80	48	4744	–	–
EK 6041 L PPL	600 x 400	558 x 90 x 80	–	–	4748	–
EK 6042	600 x 400	279 x 179 x 150	18	4724	–	–
EK 6042 PPL	600 x 400	279 x 179 x 150	–	–	4728	–
EK 6021 Q	600 x 400	358 x 279 x 80	18	79364	–	–
EK 6021 Q PPL	600 x 400	358 x 279 x 80	–	–	79368	–
EK 6022 Q	600 x 400	358 x 279 x 150	12	4774	–	–
EK 6022 Q PPL	600 x 400	358 x 279 x 150	–	–	4778	–
EK 6022 L	600 x 400	558 x 179 x 150	12	4714	–	–
EK 6022 L PPL	600 x 400	558 x 179 x 150	–	–	4718	–
EK 6021	600 x 400	558 x 179 x 80	24	1944	–	–
EK 6021 PPL	600 x 400	558 x 179 x 80	–	–	1948	–
EK 6023 L	600 x 400	558 x 179 x 215	24	4784	–	–
EK 6023 L PPL	600 x 400	558 x 179 x 215	–	–	4788	–

Order no. = on stock

Order no. = not on stock

BLUE PPL BLACK



Polystyrene

Polystyrene is very hard and keeps its shape due to its amorphous structure

6 sizes can be combined

with Euro containers with **600 x 400 mm base**

Smooth interior walls

for easy cleaning

Drainage holes

in the insert boxes for automated storage on request

Insert boxes for EF range Euro containers



Container 600 x 400 mm

Insert box	H (mm)	Divider
EK 110-N	96	1/32

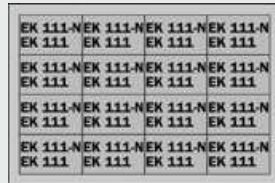

Container 600 x 400 mm

Insert box	H (mm)	Divider
EK 111-N	96	1/16
EK 111	110	1/16

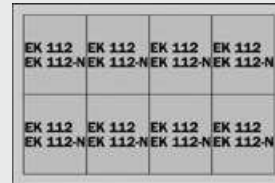

Container 600 x 400 mm

Insert box	H (mm)	Divider
EK 112-N	96	1/8
EK 112	110	1/8



Container 600 x 400 mm

Insert box	H (mm)	Divider
EK 113-N	96	1/4
EK 113	110	1/4

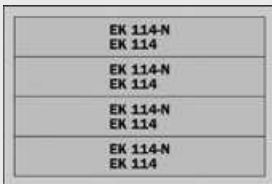

Container 600 x 400 mm

Insert box	H (mm)	Divider
EK 114-N	96	1/4 longitudinal
EK 114	110	1/4 longitudinal



Container 600 x 400 mm

Insert box	H (mm)	Divider
EK 115-N	96	1/2 longitudinal
EK 115	110	1/2 longitudinal

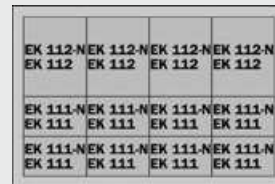

Container 600 x 400 mm

Insert box	Height (mm)
4x EK 112 /-N	96 / 110
8x EK 111 /-N	96 / 110

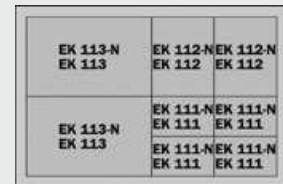

Container 600 x 400 mm

Insert box	Height (mm)
2x EK 113 /-N	96 / 110
2x EK 112 /-N	96 / 110
4x EK 111 /-N	96 / 110

Insert boxes for Euro containers with 600 x 400 mm base

Item	for containers (mm)	Dimensions L x W x H (mm)	PU	Order no.
EK 110-N PS	600 x 400	68 x 87 x 96	96	4704
EK 110-N PPL				4708
EK 111-N PS	600 x 400	137 x 87 x 96	48	4364
EK 111-N PPL				4368
EK 111 PS	600 x 400	137 x 87 x 110	48	22644
EK 111 PPL				22648
EK 112-N PS	600 x 400	174 x 137 x 96	40	4374
EK 112-N PPL				4378
EK 112 PS	600 x 400	174 x 137 x 110	40	22634
EK 112 PPL				22638
EK 113-N PS	600 x 400	274 x 174 x 96	36	4384
EK 113-N PPL				4388
EK 113 PS	600 x 400	274 x 174 x 110	36	22624
EK 113 PPL				22628
EK 114-N PS	600 x 400	550 x 87 x 96	36	4394
EK 114-N PPL				4398
EK 114 PS	600 x 400	550 x 87 x 110	36	22614
EK 114 PPL				22618
EK 115-N PS	600 x 400	550 x 174 x 96	18	4404
EK 115-N PPL				4408
EK 115 PS	600 x 400	550 x 174 x 110	18	22604
EK 115 PPL				22608
EK 14-4 PS	600 x 400	355 x 184 x 80	48	7184
EK 14-4 PPL				7188

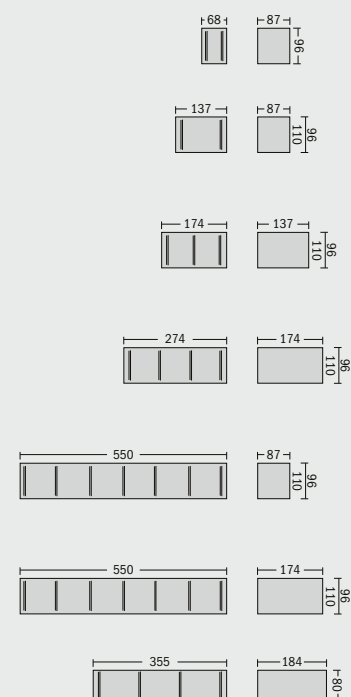

Boxes / containers

Modular shelving

Longspan racking

Pallet racking

Cantilever racking

Mezzanines / platforms

On-line shelving / KDR shelving

Semi-automated solutions

Logistics systems

Appendix



Insert boxes
for drawer partitioning

► Polypropylene

resistant to most oils, acidic and alkaline solutions,
when used properly dimensionally stable from -20°
to +100°C



► Polystyrene

Polystyrene is very hard and keeps its shape due to its
amorphous structure

► Smooth interior walls



for easy cleaning

Insert boxes for drawer partitioning

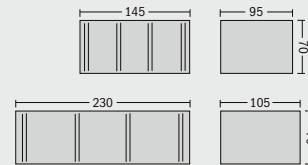
Item	Dimensions L x W x H (mm)	PU	Order no.	
				
EK 14-2 PP	145 x 95 x 70	20	7101	7104
EK 14-3 PP	230 x 105 x 70	49	—	7174



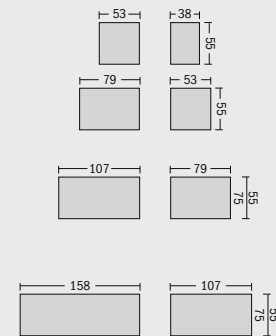

Insert boxes for drawer partitioning

Item	Dimensions L x W x H (mm)	PU	Order no.	
				
EK 10 PS	53 x 38 x 55	40	22761	22764
EK 9 PS	79 x 53 x 55	40	22751	22754
EK 8 PS	107 x 79 x 55	30	22741	22744
EK 12 PS	107 x 79 x 75	20	22781	22784
EK 7 PS	158 x 107 x 55	15	22731	22734
EK 11 PS	158 x 107 x 75	10	22771	22774



Insert boxes for drawer partitioning

Item	Dimensions L x W x H (mm)	PU	Order no.	
				
EK 301 PS	58 x 29 x 30	50	4541	—
EK 303 PS	116 x 58 x 30	60	4561	—
EK 304 PS	116 x 116 x 30	30	4571	—
EK 351 PS	53 x 40 x 35	40	22571	22574
EK 352 PS	79 x 53 x 35	50	22581	22584
EK 353 PS	105 x 79 x 35	30	22591	22594
EK 401 PS	54 x 54 x 40	40	—	4654
EK 402 PS	54 x 108 x 40	60	—	4664
EK 403 PS	108 x 108 x 40	24	—	4674
EK 501 PS	72 x 52 x 50	40	4901	4904
EK 502 PS	72 x 104 x 50	40	4911	4914
EK 503 PS	144 x 104 x 50	20	4921	4924
EK 504 PS	144 x 208 x 50	10	4931	4934

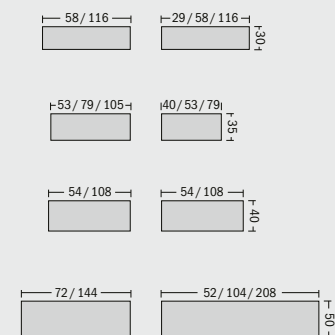

Order no. = on stock

Order no. = not on stock

Boxes /
containersModular
shelvingLongspan
rackingPallet
rackingCantilever
rackingMezzanines /
platformsOn-line shelving /
KDR shelvingSemi-automated
solutionsLogistics
systems

Appendix

QX range – Quality plus X

QX range

When developing the QX family, SSI SCHAEFER's engineers moved away from the traditional container design with numerous ribs. We have succeeded in combining the best elements of recent product developments to create a state-of-the-art container.

Hollow-wall technology is used to make the container exceptionally sturdy. The variant with a vibration-welded base (VS) is capable of handling content loads of up to 70 kg. Naturally, the container is also suitable for conveyor systems and automatic handling systems.

Optionally, the QX can be produced with notches for fixing of vacuum-formed inserts or other component fittings. Standard containers have smooth inner walls. This is an advantage for on-board networks because nothing can jam. The smooth inner walls are also easy to keep clean.

However, the absolute highlight of this product is the innovative stacking rim. It is designed to completely prevent coarse dust and spray water (as per class IP 44) from entering the container.

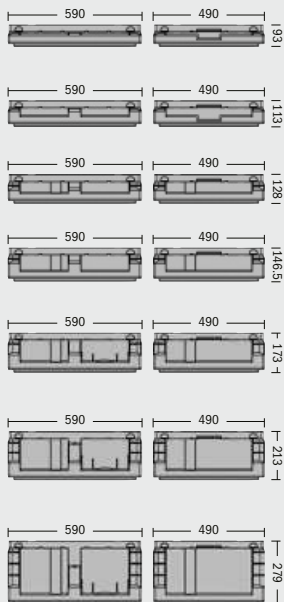
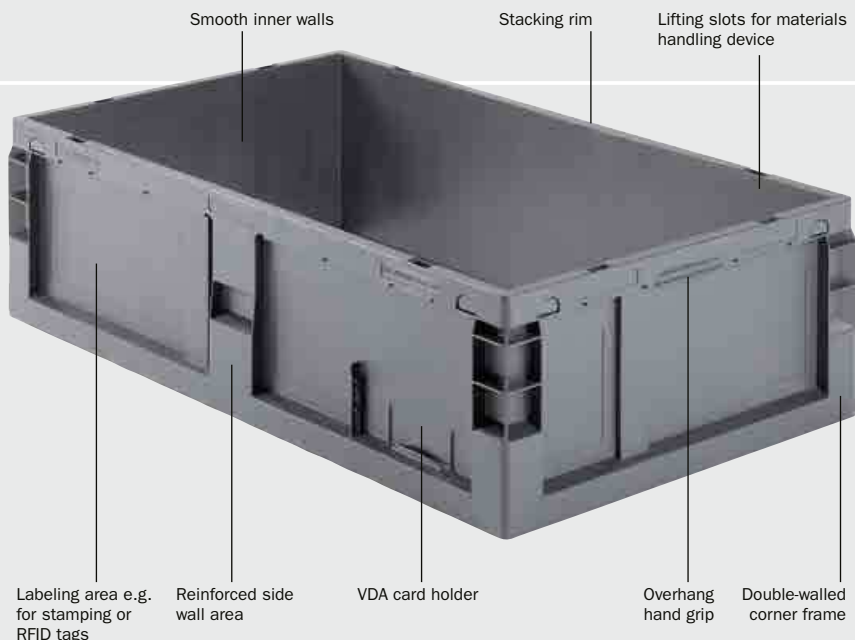

QX container – base dimensions 600 x 500 mm

Item	Internal dimensions (base) L x W x H (mm)	Usable internal height when stacked (mm)	Volume (liters)	Base	Order No.
QX 65094 GL01 PP	546 x 446 x 87	67.8	20.7	GL	1123676
QX 65094 VS01 PP	546 x 446 x 71	51.0	17.2	VS	1123680
QX 65114 GL01 PP	546 x 446 x 107	87.8	25.5	GL	56920
QX 65114 VS01 PP	546 x 446 x 91	71.0	22.1	VS	1123682
QX 65128 GL01 PP	546 x 446 x 121	101.8	28.8	GL	1123678
QX 65128 VS01 PP	546 x 446 x 105	85.0	25.5	VS	1123684
QX 65147 GL01 PP	535 x 435 x 140.5	121.5	32.6	GL	56950
QX 65147 VS01 PP	544 x 444 x 124.5	104.5	30.0	VS	56970
QX 65174 GL01 PP	535 x 435 x 167	148.0	38.9	GL	56980
QX 65174 VS01 PP	544 x 444 x 151	131.0	36.5	VS	57000
QX 65213 GL01 PP	535 x 435 x 207	188.0	48.2	GL	57010
QX 65213 VS01 PP	544 x 444 x 191	170.5	46.1	VS	57030
QX 65280 GL01 PP	535 x 435 x 273	254.0	63.5	GL	57040
QX 65280 VS01 PP	544 x 444 x 257	237.0	62.1	VS	57060

GL Smooth base (max. content load 20 kg)

VS Vibration-welded base (max. content load 70 kg)

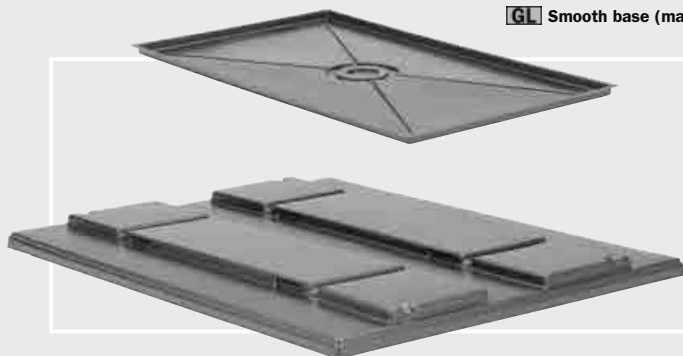

Pallet covers and lids

Other colors and sizes available on request.

Item	L x W (mm)		Order No.
QX-D 65	600 x 500	Lid	1200458
QX-D 106	1,000 x 600	Lid	1200121
QX-D 106-1	1,000 x 600	Slip-on lid	5810003
QX-A 1210	1,200 x 1,000	Pallet cover	5810005

Order No. = on stock

Order No. = not on stock

QX range

BLACK

GRAY

Additional colors available on request



- ▶ **Polypropylene**
resistant to most oils, acidic and alkaline solutions, sound insulation effect when used on conveying sections, when used properly dimensionally stable from -20° to +100°C
- ▶ **Keeps its shape and robust**
- ▶ **Reinforced base**
for reliable and safe storage using ASPW systems
- ▶ **Double-walled corner frame design**
for high torsion resistance with high stacking loads
- ▶ **Lifting slots**
for automated handling
- ▶ **Overhand hand grips**
at both short sides
- ▶ **Innovative rim designed for water run-off**
for protection against water and foreign bodies (Ø > 1 mm) to IP 44
- ▶ **Optional drainage holes in the base**
as per the VDS directive for HHS3 classification
- ▶ **Conductive models**
available on request

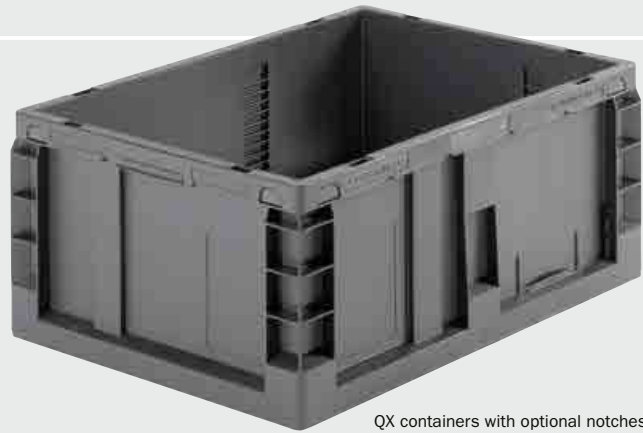

QX containers with optional notches



Smooth standard base GL01 (max. content load 20 kg)

Reinforced base with vibration-welded plate VS01 (max. content load 70 kg)



Matching plastic pallets

on request

QX container – base dimensions 1,000 x 600 mm

Item	Internal dimensions (base) L x W x H (mm)	Usable internal height when stacked (mm)	Volume (liters)	Base	Order No.
QX 106094 GL01 PP	929 x 535 x 86	67.0	44.0	GL	57810
QX 106094 VS01 PP	938 x 544 x 70	50.0	36.0	VS	57830
QX 106114 GL01 PP	929 x 535 x 106	87.0	54.0	GL	57780
QX 106114 VS01 PP	938 x 544 x 91	71.0	46.0	VS	57800
QX 106147 GL01 PP	929 x 535 x 139	120.0	71.2	GL	57750
QX 106147 VS01 PP	938 x 544 x 124	104.0	63.5	VS	57770
QX 106174 GL01 PP	929 x 535 x 167	148.0	83.0	GL	57070
QX 106174 VS01 PP	938 x 544 x 151	131.0	77.1	VS	57090
QX 106213 GL01 PP	929 x 535 x 207	188.0	102.9	GL	56860
QX 106213 VS01 PP	938 x 544 x 191	170.5	97.5	VS	57110
QX 106280 GL01 PP	929 x 535 x 273	254.0	135.7	GL	57120
QX 106280 VS01 PP	938 x 544 x 257	237.0	131.1	VS	57140
QX 106415 GL01 PP	929 x 535 x 408	389.0	202.8	GL	57150
QX 106415 VS01 PP	938 x 544 x 392	372.0	200.0	VS	56710

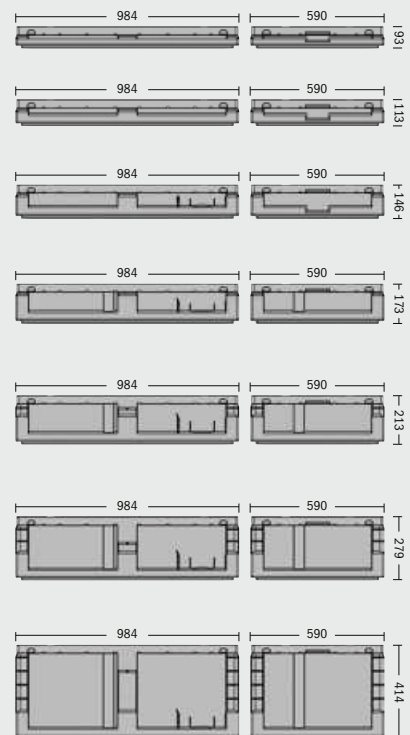

GL Smooth base (max. content load 20 kg)

VS Vibration-welded base (max. content load 70 kg)

Boxes / containers

Modular shelving

Longspan racking

Pallet racking

Cantilever racking

Mezzanines / platforms

On-line shelving / KDR shelving

Semi-automated solutions

Logistics systems

Appendix

R-KLT range to VDA 4500

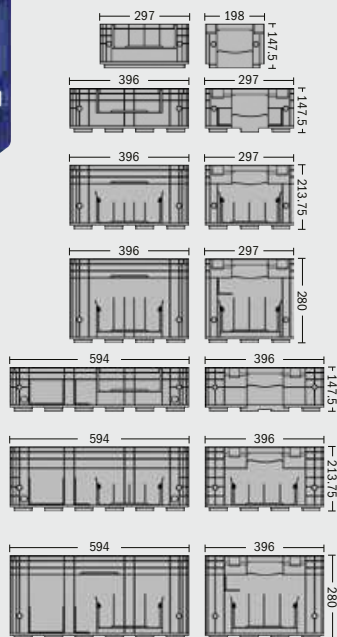
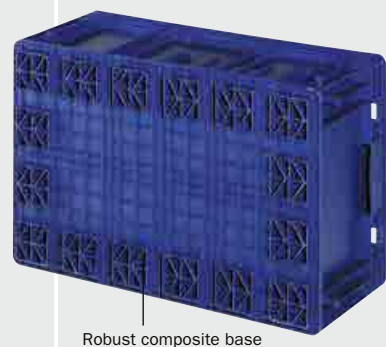
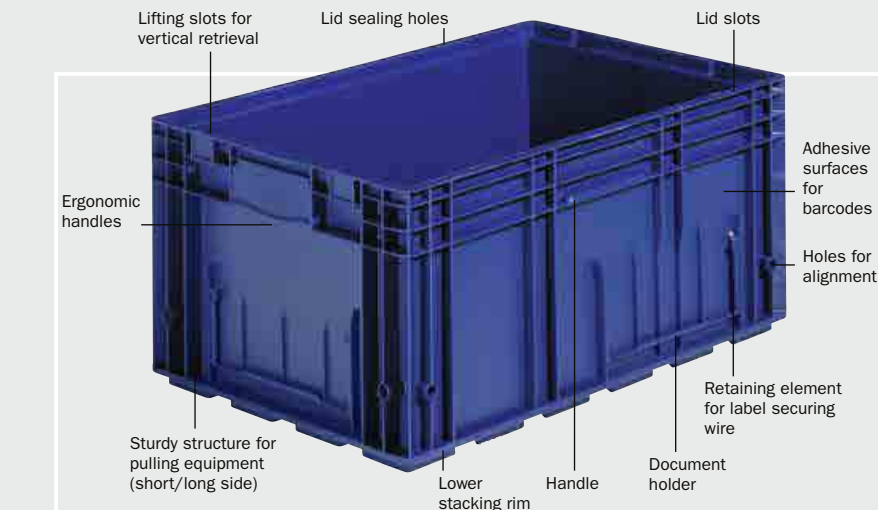

RAL 5003

- **Polypropylene**
resistant to most oils, acidic and alkaline solutions, sound insulation effect when used on conveying sections, when used properly dimensionally stable from -20° to +100°C
- **Keeps its shape and robust**
- **Fully recyclable**
- **Ergonomic handles**
- **Lifting slots**
for automated handling
- **Optimized usable volume**
- **Smooth interior walls**
for easy cleaning
- **Compatible**
with all Euro dimension containers and KLT models
- **VDA standard 4500**

R-KLT containers with composite base

Item	Internal dimensions of the base L x W x Usable H (mm)	Volume (liters)	Order No.
R-KLT 3215	243 x 162 x 129.5	5.3	20704
R-KLT 4315	346 x 265 x 109.5	10.1	20714
R-KLT 4322	346 x 265 x 176.1	16.2	79384
R-KLT 4329	346 x 265 x 242.3	22.3	20724
R-KLT 6415	544 x 364 x 109.5	21.8	20794
R-KLT 6422	544 x 364 x 175.8	34.9	79414
R-KLT 6429	544 x 364 x 242.0	48.1	20734

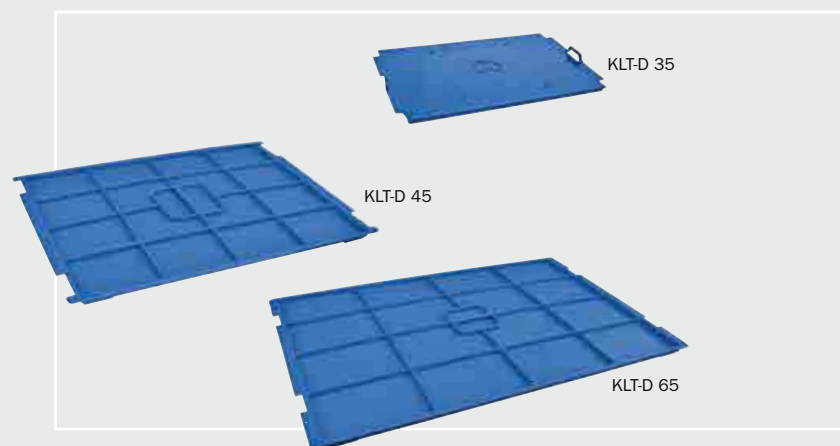

On-line shelving

from page G1

Lid

As per VDA recommendation 4500. Compatible with the range RL-KLT. Dustproof closing. Containers can also be stacked safely with a lid. Material: polypropylene. Color: blue (RAL 5005).

Item	for containers L x W (mm)	Order No.
KLT-D 35	297 x 198	20854
KLT-D 45	396 x 297	20834
KLT-D 65	594 x 396	20844

Order no. = on stock Order no. = not on stock

PPL BLACK



- ▶ **Polypropylene**
resistant to most oils, acidic and alkaline solutions, sound insulation effect when used on conveying sections, when used properly dimensionally stable from -20° to +100°C
- ▶ **Keeps its shape and robust**
- ▶ **Fully recyclable**
- ▶ **Ergonomic handles**
- ▶ **Ergonomic handles**
- ▶ **Lifting slots**
for automated handling
- ▶ **Optimized usable volume**
- ▶ **Smooth interior walls**
for easy cleaning
- ▶ **Compatible**
with all Euro dimension containers and KLT models
- ▶ **VDA standard 4504 / 4 - 10**

▶ **Electrostatic discharge polypropylene (PPL)**

Specific contact resistance	normal PE/PP 10 ¹⁸ Ohm x cm <	PPL ≥ 1 x 10 ⁴ x ≤ 1 x 10 ¹⁰ Ohm
Specific surface resistance	10 ¹⁴ Ohm	≥ 1 x 10 ⁴ x ≤ 1 x 10 ¹⁰ Ohm

R-KLT range to VDA 4504 – electrostatic discharge

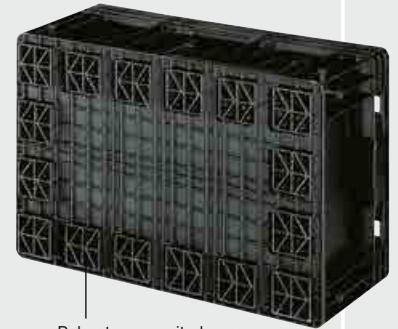
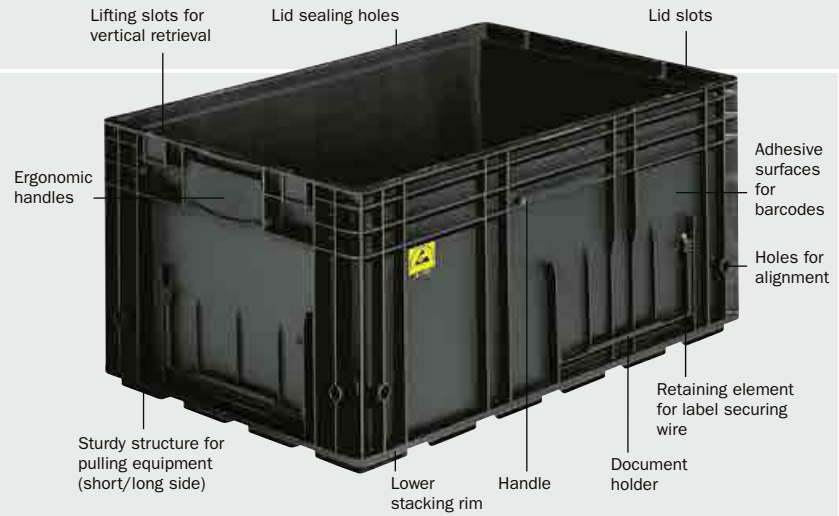

Robust composite base

R-KLT containers – electrostatic discharge

Item	Internal dimensions of the base L x W x Usable H (mm)	Volume (liters)	Order No.
KLT 3115 ESD	243 x 162 x 129.5	5.3	20888
R-KLT 4115 ESD	346 x 265 x 109.5	10.1	20718
R-KLT 4129 ESD	346 x 265 x 242.3	22.3	20728
R-KLT 6115 ESD	544 x 364 x 109.5	21.8	20798
R-KLT 6122 ESD	544 x 364 x 175.8	34.9	79418
R-KLT 6129 ESD	544 x 364 x 242.0	48.1	20738

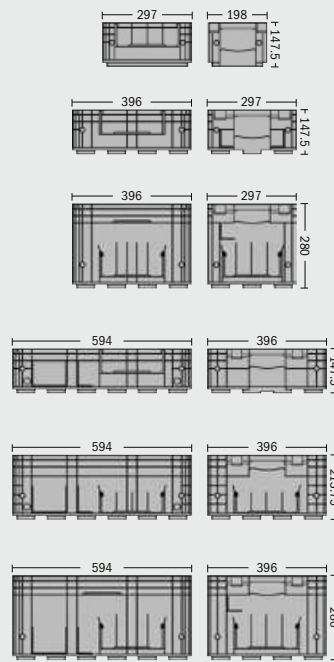

Lid

As per VDA recommendation 4504.
Compatible with the range RL-KLT.
Dustproof closing. Containers can also be stacked safely with a lid. Material: polypropylene, electrostatic discharge. Color: black.



Item	for containers L x W (mm)	Order No.
KLT-D 31 ESD	297 x 198	20838
KLT-D 41 ESD	396 x 297	20848
KLT-D 61 ESD	594 x 396	20858

Boxes / containers
Modular shelving
Longspan racking
Pallet racking
Cantilever racking
Mezzanines / platforms
On-line shelving / KDR shelving
Semi-automated solutions
Logistics systems
Appendix

RL-KLT range to VDA 4500

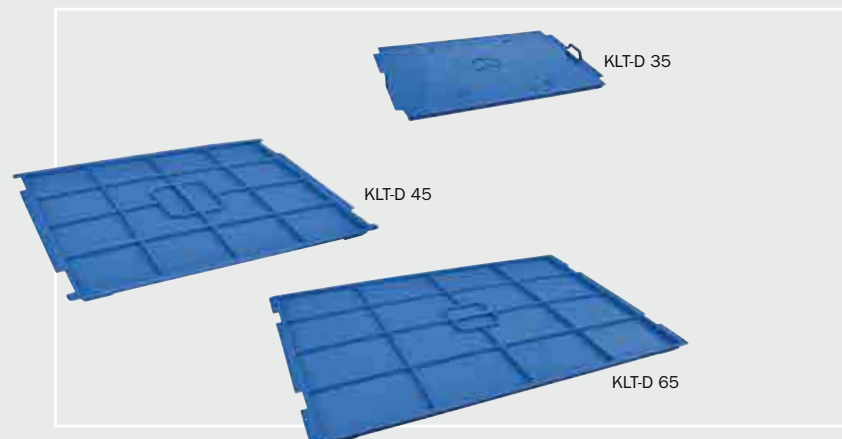
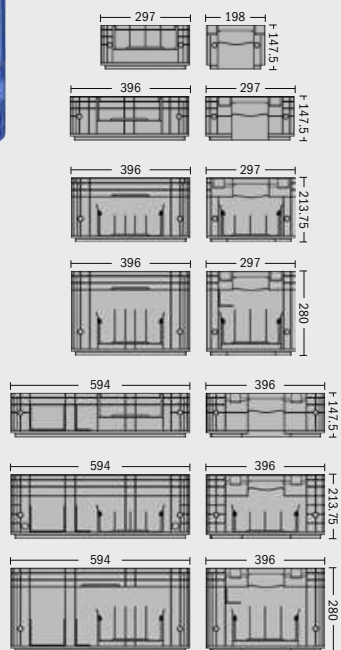
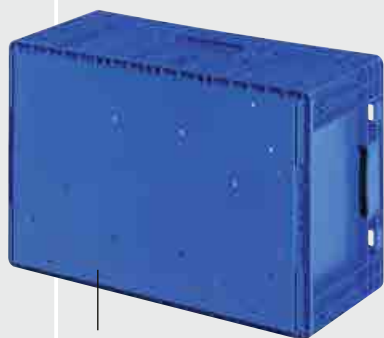
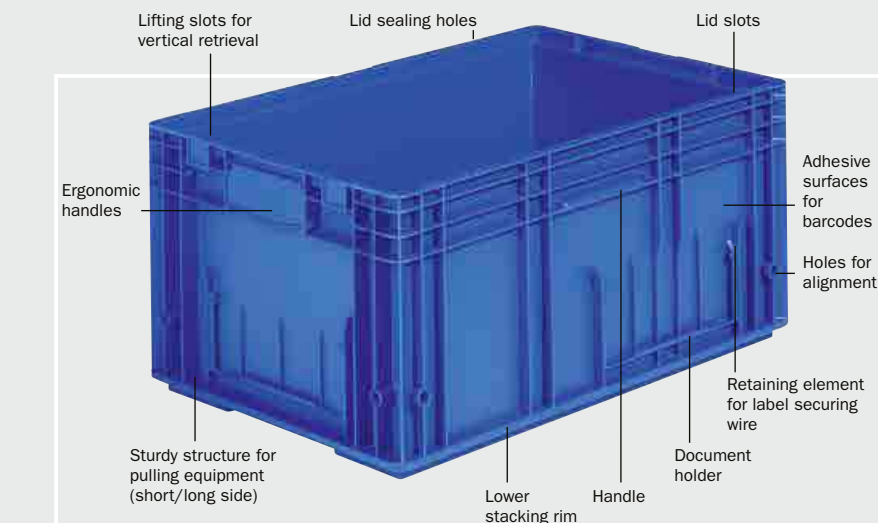

RAL 5005

Icons: RAL 5005, EU, PP, Recycle, AKL, AKL, AKL

- **Polypropylene**
resistant to most oils, acidic and alkaline solutions, sound insulation effect when used on conveying sections, when used properly dimensionally stable from -20° to +100°C
- **Keeps its shape and robust**
- **Fully recyclable**
- **Ergonomic handles**
- **Lifting slots**
for automated handling
- **Optimized usable volume**
- **Smooth interior walls**
for easy cleaning
- **Compatible**
with all Euro dimension containers and KLT models
- **Optional drain holes in the base**
as per the VDS directive for HHS3 classification (with the exception of RL-KLT 3147)
- **VDA standard 4500**

RL-KLT containers with smooth base

Item	Internal dimensions of the base L x W x Usable H (mm)	Volume (liters)	Order No.
RL-KLT 3147	243 x 162 x 129.5	5.3	20744
RL-KLT 4147	345 x 260 x 129.5	11.8	20754
RL-KLT 4213	345 x 260 x 196.1	17.9	79374
RL-KLT 4280	345 x 260 x 262.3	24.2	20764
RL-KLT 6147	544 x 359 x 129.5	25.7	20784
RL-KLT 6213	544 x 359 x 195.8	38.9	79404
RL-KLT 6280	544 x 359 x 262.0	52.1	20774

On-line shelving

from page G1

Lid

As per VDA recommendation 4500.
Compatible with the range RL-KLT.
Dustproof closing. Containers can also be stacked safely with a lid. Material: polypropylene. Color: blue (RAL 5005).

Item	for containers L x W (mm)	Order No.
KLT-D 35	297 x 198	20854
KLT-D 45	396 x 297	20834
KLT-D 65	594 x 396	20844

Order No. = on stock

PPL BLACK



- **Polypropylene**
resistant to most oils, acidic and alkaline solutions, sound insulation effect when used on conveying sections, when used properly dimensionally stable from -20° to +100°C
- **Keeps its shape and robust**
- **Fully recyclable**
- **Ergonomic handles**
- **Lifting slots**
for automated handling
- **Optimized usable volume**
- **Smooth interior walls**
for easy cleaning
- **Compatible**
with all Euro dimension containers and KLT models
- **Optional drain holes in the base**
as per the VDS directive for HHS 3 classification (with the exception of KLT 3115 ESD)

► **Electrostatic discharge polypropylene (PPL)**

Specific contact resistance	normal PE/PP 10 ¹⁸ Ohm x cm <	PPL ≥ 1 x 10 ⁴ x ≤ 1 x 10 ¹⁰ Ohm
Specific surface resistance	10 ¹⁴ Ohm	≥ 1 x 10 ⁴ x ≤ 1 x 10 ¹⁰ Ohm

RL-KLT range to VDA 4504 – electrostatic discharge

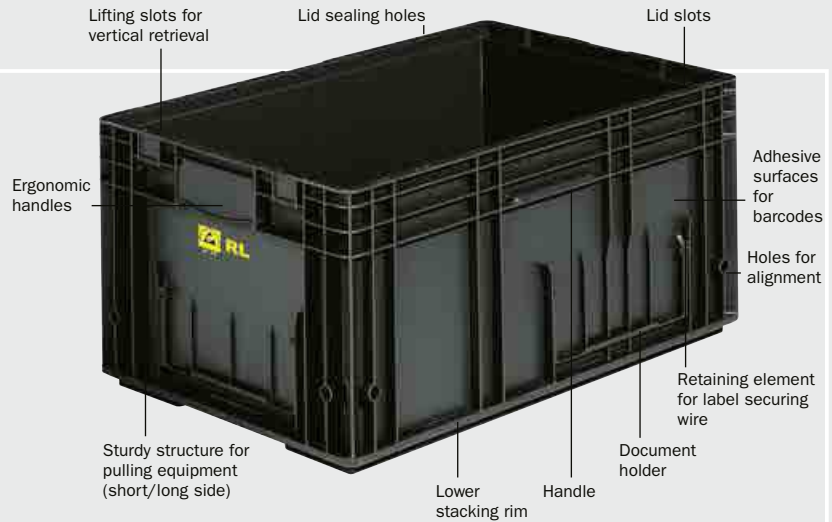

RL-KLT containers – electrostatic discharge

Item	Internal dimensions of the base L x W x Usable H (mm)	Volume (liters)	Order No.
KLT 3115 ESD	243 x 162 x 129.5	5.3	20888
RL-KLT 4047 ESD	345 x 260 x 129.5	11.8	20898
RL-KLT 4013 ESD	345 x 260 x 196.1	17.9	1123608
RL-KLT 4080 ESD	345 x 260 x 262.3	24.2	20908
RL-KLT 6047 ESD	544 x 359 x 129.5	25.7	20868
RL-KLT 6013 ESD	544 x 359 x 195.8	38.9	1123618
RL-KLT 6080 ESD	544 x 359 x 262.0	52.1	20878

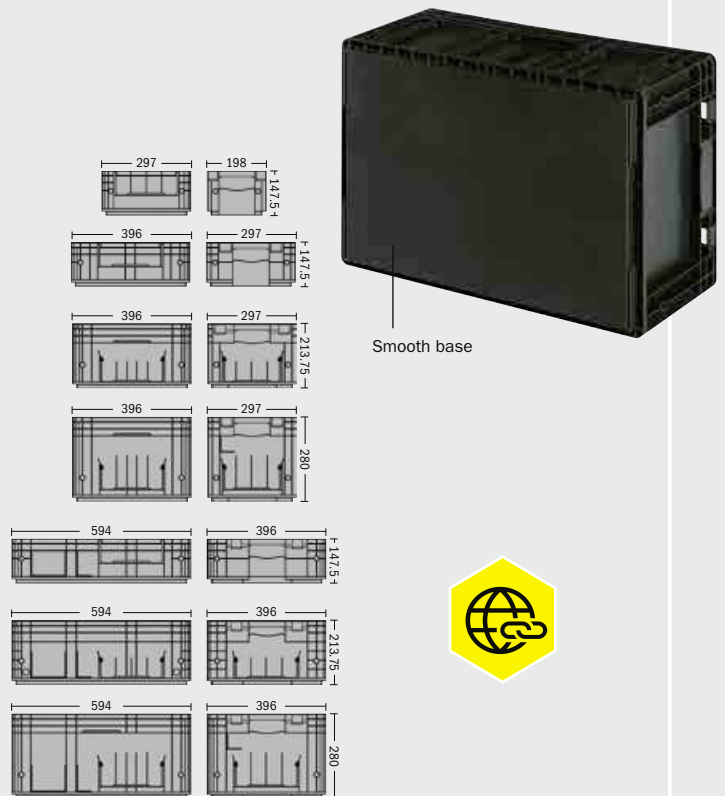

Lid

As per VDA recommendation 4504.
Compatible with the range RL-KLT.
Dustproof closing. Containers can also be stacked safely with a lid. Material: polypropylene, electrostatic discharge. Color: black.

Item	for containers L x W (mm)	Order No.
KLT-D 31 ESD	297 x 198	20838
KLT-D 41 ESD	396 x 297	20848
KLT-D 61 ESD	594 x 396	20858



Boxes / containers

Modular shelving

Longspan racking

Pallet racking

Cantilever racking

Mezzanines / platforms

On-line shelving / KDR shelving

Semi-automated solutions

Logistics systems

Appendix



RAL 5012



C-KLT range to VDA 4500

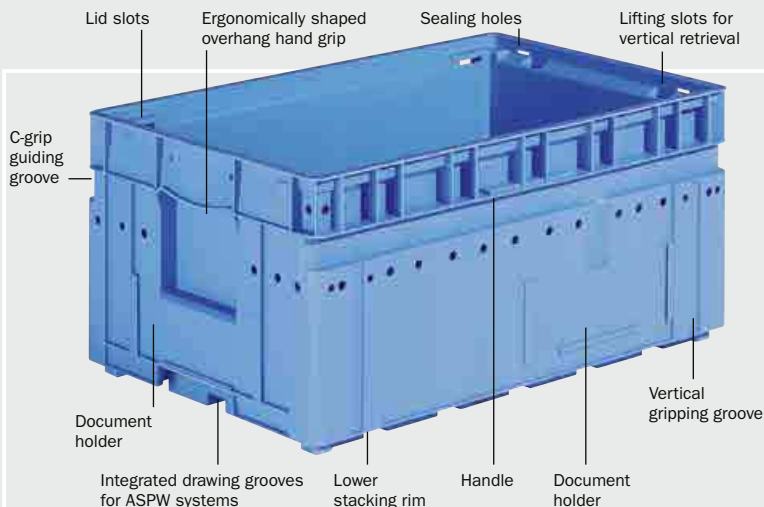

Robust composite base



- ▶ **Polypropylene**
resistant to most oils, acidic and alkaline solutions, sound insulation effect when used on conveying sections, when used properly dimensionally stable from -20° to +100°C
- ▶ **Keeps its shape and robust**
- ▶ **Fully recyclable**
- ▶ **Smooth interior walls**
for easy cleaning
- ▶ **Manual and automatic handling**
- ▶ **Secure stand and interlocking stacking**
due to base ripping with stacking feet
- ▶ **Usable in ASPW systems**
due to drawing grooves on the short and sides
- ▶ **Horizontal and vertical gripping**
using the KLT grooves and lifting slots
- ▶ **Gripping/clamping technology on the long side**
due to two vertical grooves
- ▶ **Automated parts removal**
and transfer to empty stack
- ▶ **Hazardous goods container**
available with UN labeling
- ▶ **VDA standard 4500**

C-KLT containers with composite base

Item	Int. dimensions of base L x W x Usable H (mm)	Volume (liters)	Filling weight max. (kg)	Stacking load max. (kg)*	Order No.
C-KLT 3214	260 x 136 x 129.9	4.7	30	400	15764
C-KLT 4314	334 x 247 x 105.5	8.7	50	600	15774
C-KLT 4321	334 x 247 x 171.8	14.2	50	600	1604
C-KLT 4328	334 x 247 x 238.0	19.6	50	600	15784
C-KLT 6414	532 x 346 x 100.5	18.5	50	600	15804
C-KLT 6417	532 x 346 x 127.0	23.4	50	600	1614
C-KLT 6421	532 x 346 x 166.8	30.7	50	600	1624
C-KLT 6428	532 x 346 x 233.0	42.9	50	600	15794

* Distributed over the area

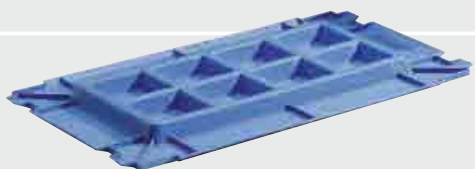

Lid

Sealable, dustproof closing.. Containers with lid, stackable, immersion depth 15 mm.

Material: polypropylene, color: blue (RAL 5012).

Item	for containers L x W (mm)	Order No.
C-KLT-D 32	297 x 198	16514
C-KLT-D 43	396 x 297	16414
C-KLT-D 64	594 x 396	16424

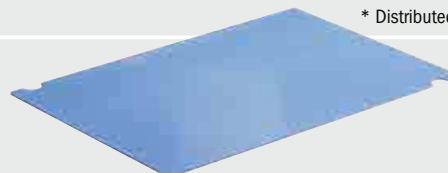

Layer separator

With rounded handles, protects sensitive stacked parts.

Material: polypropylene, color: blue (RAL 5012).

Item	Dimensions L x W x H (mm)	Order No.
ZL 43	329.0 x 243.0 x 3	39684
ZL 64	526.5 x 341.5 x 3	39694

Order No. = on stock

RAL 5012



- ▶ **Folding KLT**
folding dimension: 94.5 mm, stacked 79.5 mm, filling weight: 20 kg
- ▶ **Durable**
due to sturdy container design
- ▶ **Fully compatible with all KLT boxes**, especially suitable for use in the automotive industry
- ▶ **VDA standard 4500**
- ▶ **Volume reduction**
of up to 65% for return transport

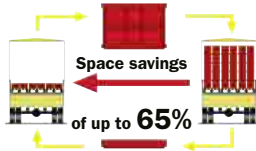

▶ **Conductive polypropylene (PPL)**

PPL BLACK



Specific contact resistance	normal PE/PP 10 ¹⁸ Ohm x cm <	PPL 10 ³ Ohm x cm
Specific surface resistance	10 ¹⁴ Ohm	10⁴ Ohm

Folding KLT as per VDA 4500

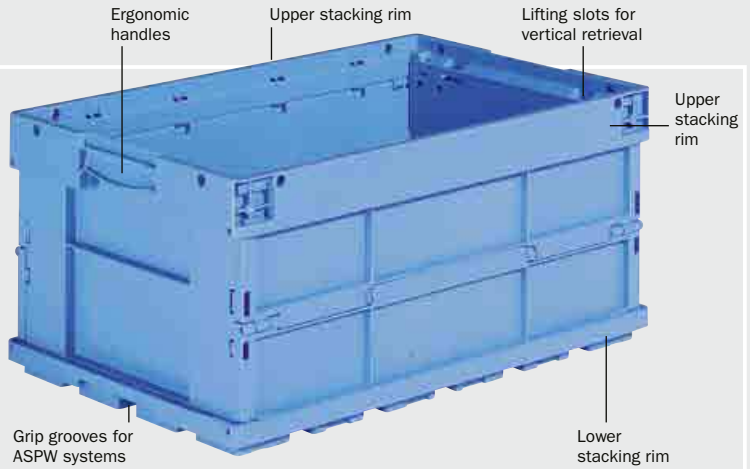

Robust composite base

Folding KLT as per VDA 4500 composite base

Item	Internal dimensions of the base L x W x Usable H (mm)	Volume (liters)	Order No.
F-KLT 6410	534 x 357 x 237.4	46.0	2204

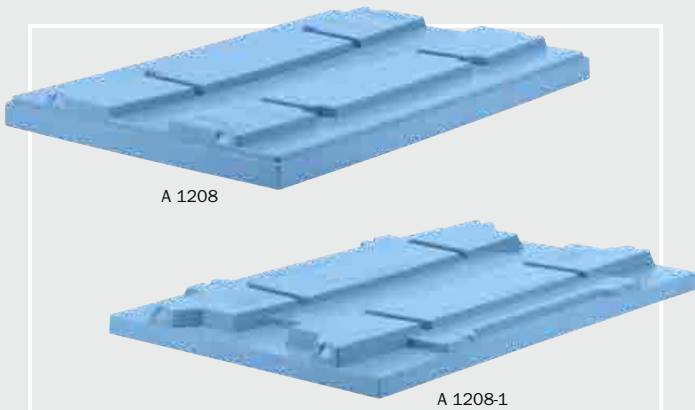

Pallet covers

For covering entire stacks of containers on a euro pallet. Designed for banding. Suitable for all KLT containers.
Other colors and sizes available on request.

Item	for pallets L x W (mm)	Order No.
A 1208	1,200 x 800	39704 –
A 1208-1	1,200 x 800	35614 –
A 1208-1 ESD	1,200 x 800	– 35718

Order No. = not on stock

Additional container versions and ranges

on request

Boxes / containers

Modular shelving

Longspan racking

Pallet racking

Cantilever racking

Mezzanines / platforms

On-line shelving / KDR shelving

Semi-automated solutions

Logistics systems

Appendix

ECOftech folding boxes for industrial applications

SSI SCHAEFER developed the ECOftech folding box with and without access openings for industrial applications. Equipped with an active locking mechanism and ergonomically shaped handles, this folding box generation can be followed up quickly and safely without any fixed order, which reduces volume by approximately 80%.

ECOftech is designed for all ASPW applications and conveyor systems and is also suitable for full automation. With a content load of 20 kg and a usable internal volume of 55 liters, the folding box has numerous applications for the industrial, commercial and service sectors.

The container variant with two-sided access opening and sliding mechanism enables especially rapid and safe access to the products. The large access opening on the short sides not only increases order picking performance but also enables articles to be removed easily when the container is stacked.

The ECOftech ECT folding box bears the "Product of the Year 2011" seal of quality. The innovative containers prevailed over the competition, taking first place in the storage and transport systems category in the best plastic product competition organized by the Pro-K association.

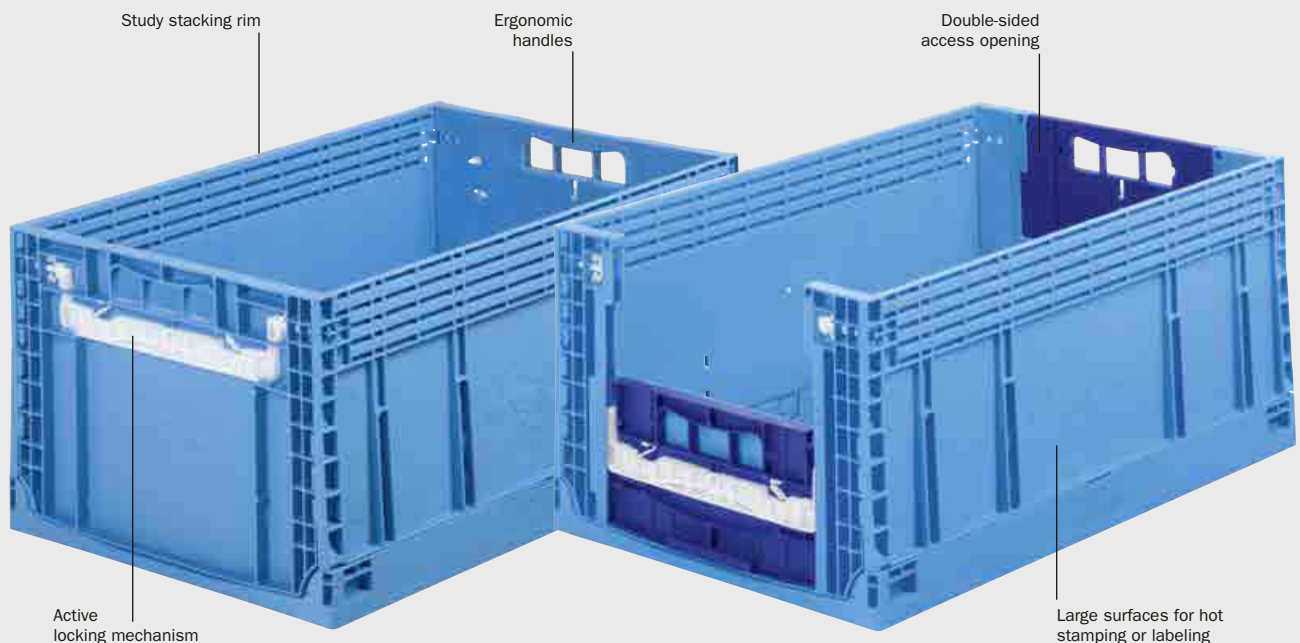

BLUE GRAY



Additional colors available on request



EC0tech ECT folding boxes

- ▶ **Polypropylene**
resistant to most oils, acidic and alkaline solutions, sound insulation effect when used on conveying sections, when used properly dimensionally stable from -20° to +100°C
- ▶ **Faster folding**
without fixed folding sequence
- ▶ **Smooth interior walls**
for easy cleaning
- ▶ **With reinforced base**
also suitable for ASPW and conveyor systems
- ▶ **Suitable for full automation**
- ▶ **Volume reduced by approx. 80%**
- ▶ **Awarded "Product of the Year 2011"**
by the Pro-K association in the "Storage and transport systems" category



EC0tech ECT 6285

Polypropylene. With an active locking mechanism and ergonomically shaped handles, alternatively with access opening on one or both sides.

Height collapsed individually: 59 mm
 Height collapsed in a stack: 49 mm
 Max. content load: 20 kg

Item	Internal dimensions of the base L x W x Usable H (mm)	Access opening W x H (mm)	Volume (liters)	Order No.
ECT 6285 GL	563 x 367 x 272.5 with active locking mechanism	-	55.8	54044 54045
ECT 6285 GL-1SK	563 x 367 x 272.5 with one-sided access opening	254 x 125	55.8	56334 56335
ECT 6285 GL-2SK	563 x 367 x 272.5 with two-sided access opening	254 x 125	55.8	56344 56345
ECT 6285 GT	563 x 367 x 269 with perforated bases and sides	-	55.8	54064 54065

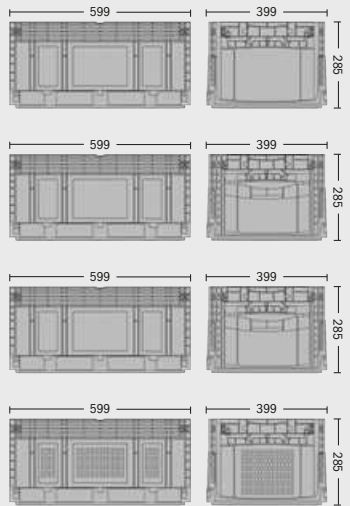

Order No. = on stock Order No. = not on stock

Other container designs

on request

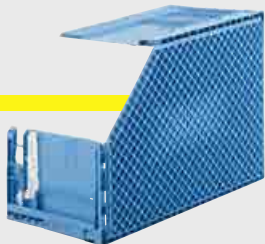

Boxes / containers
Modular shelving
Longspan racking
Pallet racking
Cantilever racking
Mezzanines / platforms
On-line shelving / KDR shelving
Semi-automated solutions
Logistics systems
Appendix

FK – the foldable and collapsible containers for warehousing and transportation

The demanding standards of the current packaging regulations require reusable transport containers. These containers are essential to the prevention of packaging waste. Depending on the type of box, folding reduces the container volume by approx. 80% for empty return transport.

All of the folding plastic containers from SSI SCHAEFER are designed

for euro pallet dimensions. The FK containers are distinguished by their large, rigid upper lip. The boxes are very torsion-resistant, which ensures safe stacking, especially when used without a lid.

The collapsible design can be used only with a lid and represents a cost-effective alternative to the folding design when shipping light goods.

BLUE **GRAY**





Additional colors available on request

- ▶ **Polypropylene**
resistant to most oils, acidic and alkaline solutions, sound insulation effect when used on conveying sections, when used properly dimensionally stable from -20° to +100°C
- ▶ **Nominal sizes:**
600 x 400 mm / 800 x 600 mm
- ▶ **Keeps its shape and robust**
- ▶ **Good handling**
thanks to ergonomic handle variants
- ▶ **Hinged, divided lid**
secured with seal
- ▶ **With base ripping**
also suitable for APSW systems
- ▶ **Volume reduced by approx. 80%**

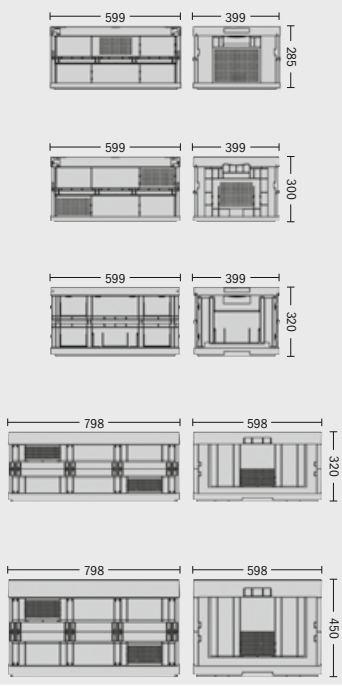
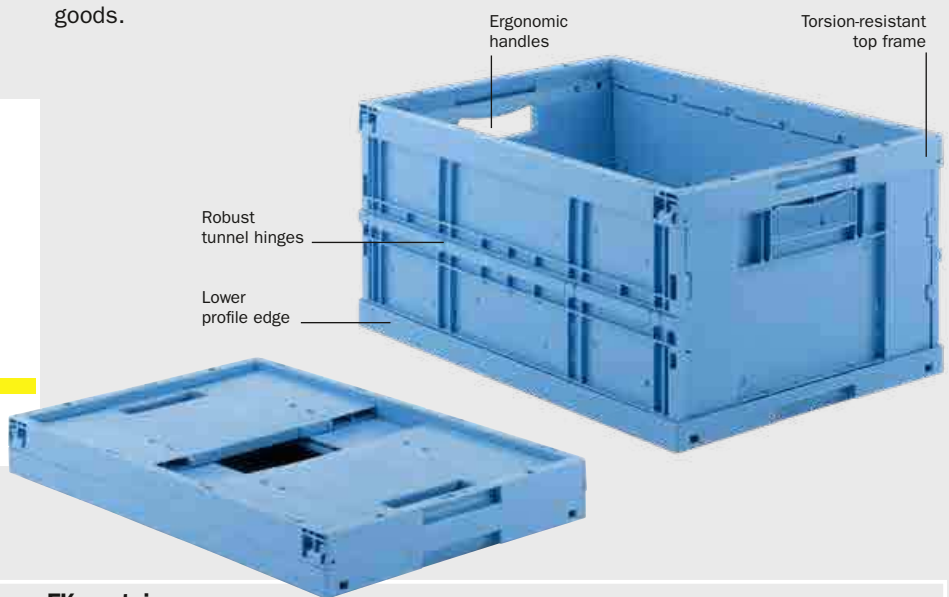

FK containers

Item	External dimensions L x W x H (mm)	Volume (liters)	H (mm) folded	H (mm) folded in stack	Order No.
FKE 6285	599 x 399 x 285	57.0	79	69	93684 93685
FK 6300	599 x 399 x 300	58.0	74	67	93384 93385
FKE 6320-2	599 x 399 x 320	65.0	79	69	90404 90405
FKE-D 6320-2	599 x 399 x 332	65,0	91	71	90424 -
FK 8320	798 x 598 x 320	126.0	135	123	9264 9265
FK 8450	798 x 598 x 450	180.0	135	123	93364 93365
FK-DL 8450	with lid, interior, front hinged			126	93474 -

Order No. = on stock **Order No.** = not on stock

Accessories for FK containers



Pallet cover

Stackable. For covering stacked FK containers. With banding grooves and indentations for stacking dollies. Height when stacked 30 mm. Color: black.

Item	Dimensions L x W x H (mm)	Order No.
ADH 86	814 x 614 x 44	93628



Roll-Fix

LTS tray with 4 swivel castors Ø 80 mm. Closed platform made of polypropylene with 15 mm high stacking rim. Suitable for FK containers 600 x 400 mm. Load capacity: 200 kg.

Item	Dimensions L x W x H (mm)	Type	Order No.
RO 460	594 x 396 x 150	with plastic castors	22201 22205
RO 461	594 x 396 x 150	with solid rubber castors	22211 22215



Dolly

Dolly with 2 swivel castors and 2 rigid castors Ø 125 mm, ground clearance 115 mm, load capacity up to 450 kg. The dollies can be stacked securely for return transport and storage. Height when stacked 130 mm. The maximum stacking height on the pallet is 1.80 m.

The dolly guarantees easy transport of the FK containers in the order picking zone and within the company. The dolly is suitable for the transportation with forklifts (ground clearance 115 mm).

Item	Dimensions L x W x H (mm)	Order No.
RLP 86	800 x 600 x 200	93608



Boxes / containers

Modular shelving

Longspan racking

Pallet racking

Cantilever racking

Mezzanines / platforms

On-line shelving / KDR shelving

Semi-automated solutions

Logistics systems

Appendix

Nesting storage and transport – saves space when empty



Nesting storage and transport containers offer economic solutions and diverse applications for reusable transport logistics and order picking.

The three basic options for reducing the volume of containers with rigid outer walls are:

- ▶ Tapered containers with bail arms – stackable either in or on top of each other using 180° lockable bail arms (see KMB with bail arms).
- ▶ Stack and nest containers can be stacked with and without a lid. If they are empty they can be stacked inside each other by rotating them 180°.
- ▶ Tapered containers can only be stacked on top of each other with a lid. When empty, they can be stacked inside each other without a lid.



BLUE



Additional colors
available on request



- ▶ **Polypropylene**
resistant to most acids and alkalis, when used correctly, retains its stability at temperatures between -20° and +90° Celsius, the base material is suitable for use with foodstuffs
- ▶ **Space gain**
75% space gain when empty
- ▶ **Automatic unstacking possible**
from sides and front
- ▶ **Ergonomic**
thanks to comfortably designed hand grips
- ▶ **Easy cleaning**
thanks to smooth surfaces and optional placed water drainage holes
- ▶ **Low noise**
when used on conveying sections
- ▶ **Good grip**
on belt conveyors due to rough base
- ▶ **Barcode areas**
protected against damage and dust due to special arrangement

KMB – tapered multi-purpose containers

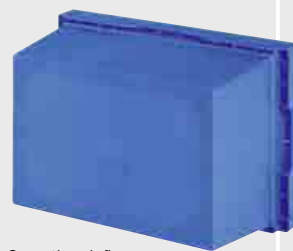

Smooth sub-floor
(max. content load 20 kg)

KMB – stack and nest multi-use containers with bail arms

Item	Internal dim. of the base L x W x Usable H (mm)	External dim. with anti-lifting device L x W (mm)	External dim. of the base L x W (mm)	Volume (liters)	Order no.
KS 3153	242 x 150 x 150	–	245 x 153	6.3	16474
KMB 422	315 x 235 x 220	407 x 299	320 x 240	18.0	75514
KMB 610	500 x 330 x 100	607 x 399	505 x 335	18.0	79324
KMB 617	500 x 330 x 170	607 x 399	505 x 335	29.0	75364
KMB 622	500 x 330 x 220	607 x 399	505 x 335	38.0	75544
KMB 627	500 x 330 x 270	607 x 399	505 x 335	47.0	75424
KMB 632	500 x 330 x 320	607 x 399	505 x 335	58.0	75604
KMB 642	500 x 330 x 420	607 x 399	505 x 335	74.0	75924
KMB 832	700 x 330 x 320	807 x 399	705 x 335	76.0	75664

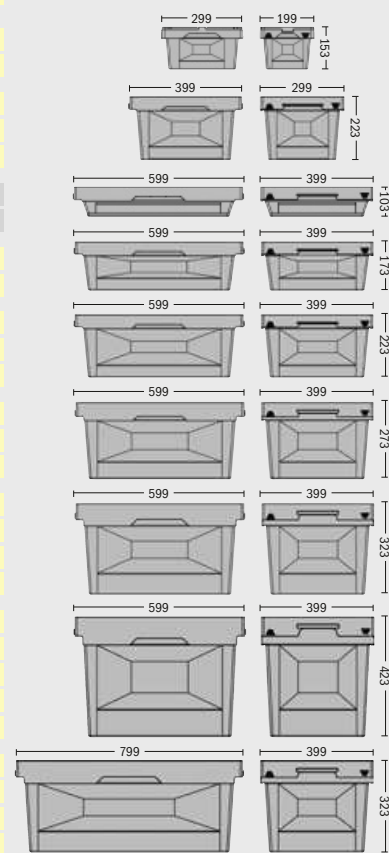

Grip ribs prevent conveyor accumulation override



Bail arm opening



Side unstacking tool aperture

Order No. = on stock

Order No. = not on stock

BLUE



In addition to:

the KMB advantages (see page A47)

- ▶ **Easy to handle bail arms**
- ▶ **High handling security**
simple handling thanks to locking function
- ▶ **Exact fit**
exact fit of the bail arms – turned out or turned in
- ▶ **Strong bail arms**
material reinforced with glass fibre
- ▶ **Each bail arm is replaceable**
- ▶ **No limitation**
of the effective volume

KMB with bail arms



Stacking principal with bail arms



Bail arms for stacking when full or empty with a rotation of 180° and locking device

KMB – stack and nest multi-use containers with bail arms

Artikel	Internal dim. of the base L x W x Usable H (mm)	External dim. with anti-lifting device L x W (mm)	External dim. of the base L x W (mm)	Incl. the following accessories	Volume (liters)	Order No.
KMB-B 422	315 x 235 x 218	407 x 299	320 x 240	2 bail arms KMB-B 300	18.0	75524
KMB-B 610	500 x 330 x 98	607 x 399	505 x 335	2 bail arms KMB-B 400	18.0	79334
KMB-B 617	500 x 330 x 168	607 x 399	505 x 335	2 bail arms KMB-B 400	29.0	75374
KMB-B 622	500 x 330 x 208	607 x 399	505 x 335	2 bail arms KMB-B 400	38.0	75554
KMB-B 627	500 x 330 x 268	607 x 399	505 x 335	2 bail arms KMB-B 400	47.0	75434
KMB-B 632	500 x 330 x 318	607 x 399	505 x 335	2 bail arms KMB-B 400	58.0	75614
KMB-B 642	500 x 330 x 418	607 x 399	505 x 335	2 bail arms KMB-B 400	74.0	75934
KMB-B 832	700 x 330 x 318	807 x 399	705 x 335	2 bail arms KMB-B 400	76.0	75674

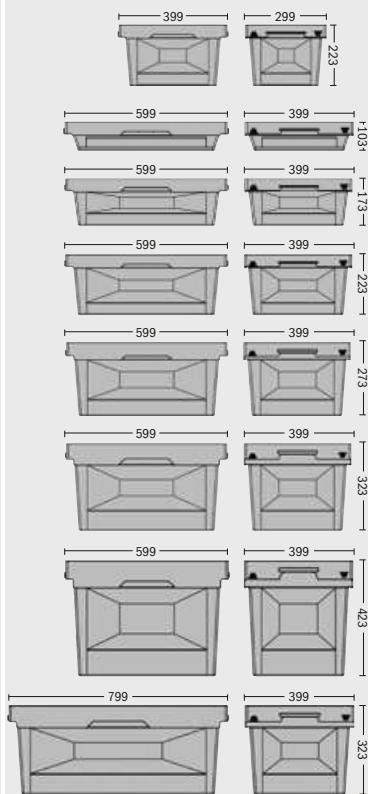

Bail arm folded for empty stacking



Bail arms folded in for stacking



Retaining mechanism of the bail arm

Order No. = on stock

Order No. = not on stock

BLUE



Additional colours on request



KMB with two-piece hinged lid

In addition to:

to the KMB advantages (see page A47)

- ▶ **Stackable when closed**
with various nominal sizes and heights
- ▶ **Optimally protects the stored goods**
against soiling
- ▶ **High access security**
due to crimp sealing
- ▶ **Additional securing**
using banding grooves
- ▶ **Large volume reduction**
when empty due to the closely fitting lid
- ▶ **Every lid can be replaced individually**
due to the hinge system

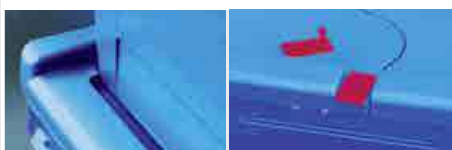

Stacking with closed lid

Sealing



Stacking with hinged lid



KMB – stack and nest multi-use containers with hinged lid

Item	Internal dim. of the base L x W x Usable H (mm)	External dim. with anti-lifting device L x W (mm)	External dim. of the base L x W (mm)	Incl. the following accessories	Volume (liters)	Order No.
KMB-DH 422	315 x 235 x 213	409 x 299	320 x 240	1x KMB-DH 43, 4x KMB-DS*	18.0	75534
KMB-DH 610	500 x 330 x 92	609 x 399	505 x 335	1x KMB-DH 64, 6x KMB-DS*	18.0	79344
KMB-DH 617	500 x 330 x 162	609 x 399	505 x 335	1x KMB-DH 64, 6x KMB-DS*	29.0	75384
KMB-DH 622	500 x 330 x 212	609 x 399	505 x 335	1x KMB-DH 64, 6x KMB-DS*	38.0	75564
KMB-DH 627	500 x 330 x 262	609 x 399	505 x 335	1x KMB-DH 64, 6x KMB-DS*	47.0	75444
KMB-DH 632	500 x 330 x 312	609 x 399	505 x 335	1x KMB-DH 64, 6x KMB-DS*	58.0	75624
KMB-DH 642	500 x 330 x 412	609 x 399	505 x 335	1x KMB-DH 64, 6x KMB-DS*	74.0	75944
KMB-DH 832	700 x 330 x 311	809 x 399	705 x 335	1x KMB-DH 84, 10x KMB-DS*	76.0	75684

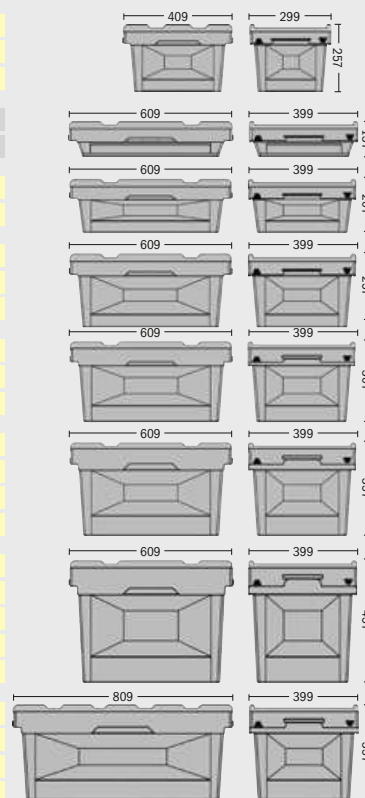

* Hinged lid KMB-DH and hinges KMB-DS



Crimp sealing option



Lid folds outwards closely



Banding grooves

Boxes / containers

Modular shelving

Longspan racking

Pallet racking

Cantilever racking

Mezzanines / platforms

On-line shelving / KDR shelving

Semi-automated solutions

Logistics systems

Appendix

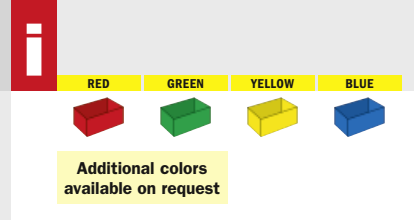

Accessories for KMB

Slip-on lid

For the KMB-B range.

Lids completely encase the container and also include a banding option along with a sealing opening. The containers remain stackable even with a lid. Loose lids can be stacked together to save space.

The roughened center area simplifies label handling.

Material: Polypropylene.

Item	for nominal size L x W (mm)	Type	Order No.
KS-D 3153	300 x 200	with living hinge and snap-lock fastener, foldable	16484
KMB-D 43	400 x 300		75344
KMB-D 64	600 x 400		75354
KMB-D 84	800 x 400		75334

KS tapered stack and nest containers

KS 18

Polypropylene, with label holders 100 x 60 mm on both sides in the lip for coding and labeling, smooth inner walls.

External dimensions top/bottom: L 775/655 x W 535/415 x H 310 mm

Item	Interior dimensions top/bottom L x W x H (mm)	Volume (liters)	Order No.
KS 18	720/640 x 480/400 x 307	90.0	15171 15172 15173 15174

Lid for KS 18		Order No.
Item	Type	
KS-D 18	with banding grooves	15291 15292 15293 15294

i Additional container versions and ranges on request



EUROFIX Box

RED GREEN YELLOW BLUE



- ▶ A “stack and nest” container means that: when empty, the containers may be nested inside one another, but when full, they can be turned through 180° and stacked on top of each other even without lids
- ▶ Enormous storage space saving without surplus stock and transport of empty containers

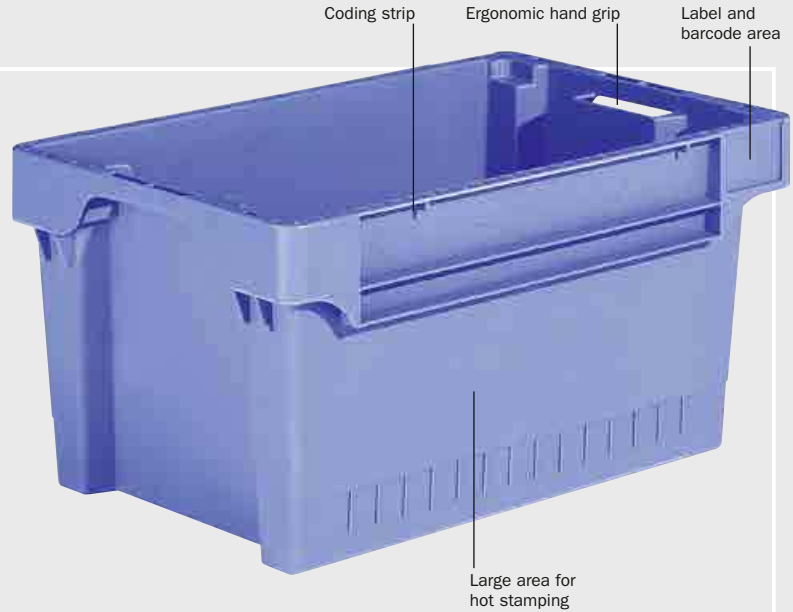
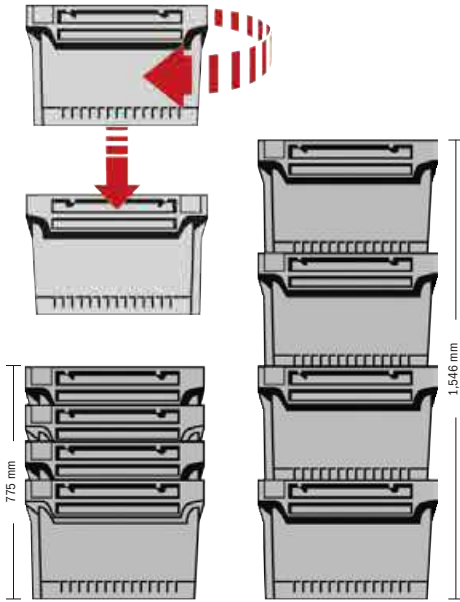

Stack and nest container EUROFIX Box

Made from polypropylene with Euro dimensions (base dimension L 600 x W 400 mm). The three heights can be stacked together. Excellent qualities of the EUROFIX Box make it ideal for use on conveyors and as an environmentally friendly order-picking and transport container.

Item	Useable internal dim. top/bottom L x W x H (mm) when stacked	Volume (liters)	Order no.
EFB 642	504/472 x 363/325 x 178	36.0	25801 25802 25803 25804
EFB 643	504/472 x 363/325 x 278	54.0	25831 25832 25833 25834
EFB 644	504/472 x 363/325 x 378	72.0	25861 25862 25863 25864

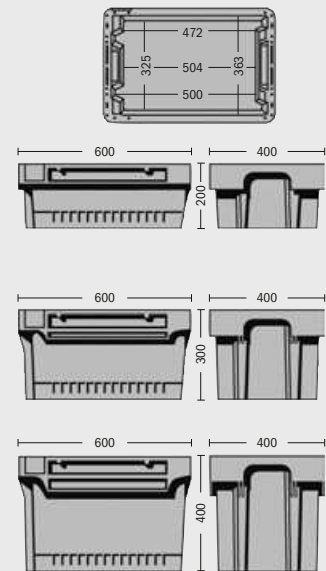

Lid

With external open hand grip (no volume loss). Compatible with all types. Space saving stackable. Stacking lugs ensure stability of stacked boxes. Banding grooves for secure banding of stapled boxes.

Item	Order no.
EFB-D	25891 25892 25893 25894



Boxes / containers
Modular shelving
Longspan racking
Pallet racking
Cantilever racking
Mezzanines / platforms
On-line shelving / KDR shelving
Semi-automated solutions
Logistics systems
Appendix

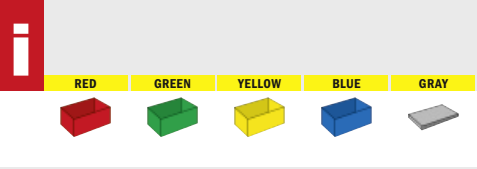





Fix-Box







Fix-Box FB 600

Polyethylene. Capable of carrying heavy loads, sturdy, with hand grips in the strong rims. Transport container for rail and road. Can be stacked when closed.

External dimensions: L 600 x W 400 x H 250 mm

Item	Internal dim. top/bottom L x W x H (mm)	Volume (liters)	Order no.
			   
FB 600	550/500 x 360/325 x 247	40.0	8351 8352 8353 8354

Lid for Fix-Box FB 600





Item	Finish	Order no.
		   
FB-D 600	with stacking corners	8361 8362 8363 8364



Fix-Box FB 603

Polypropylene, with open hand grips at the front ends, without lid.

External dimensions: L 597 x W 397 x H 300 mm





Item	Internal dim. top/bottom L x W x H (mm)	Volume (liters)	Order no.
			   
FB 603	565/530 x 364/334 x 297	57.0	12481 12482 12483 12484







Fix-Box FB 604

Polypropylene. This model is also compatible with Euro-pallet dimensions of 1,200 x 800 mm. Open hand grips on both front sides for easy handling. Can be stacked even with lid.

External dimensions: L 600 x W 400 x H 350 mm

Item	Internal dim. top/bottom L x W x H (mm)	Volume (liters)	Order no.
			   
FB 604	502/475 x 354/317 x 347	62.0	8381 8382 8383 8384

Lid for Fix-Box FB 604

Item	Finish	Order no.
		   
FB-D 604	with stacking corners	15051 15052 15053 15054

Order No. = on stock

Order No. = not on stock







Fix-Box

Fix-Box FB 530

Polypropylene. With shell hand grips. Suitable for Euro-pallets.
External dimensions: L 540 x W 320 x H 170 mm







Item	Internal dim. top/bottom L x W x H (mm)	Volume (liters)	Order no.
			   
FB 530	420/425 x 275/255 x 167	17.0	12471 12472 12473 12474

Fix-Box FB 601

Polypropylene. With shell hand grips at the front ends integrated into the stacking rim. Suitable for Euro-pallets.
External dimensions, top: L 585 x W 375 x H 200 mm



Item	Internal dim. top/bottom L x W x H (mm)	Volume (liters)	Order no.
			   
FB 601	490/420 x 330/300 x 196	30.0	8441 8442 8443 8444

Lid for Fix-Box FB 601

Item	Finish	Order no.
		
FB-D 601	with stacking corners	20905

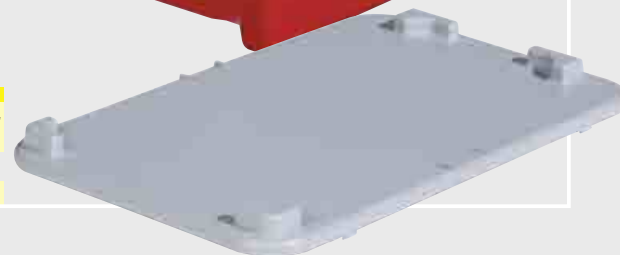

i Additional container versions and ranges
on request



Boxes /
containers

Modular
shelving

Longspan
racking

Pallet
racking

Cantilever
racking

Mezzanines /
platforms

On-line shelving /
KDR shelving

Semi-automated
solutions

Logistics
systems

Appendix

Sheet steel boxes and containers

SSI SCHAEFER's sheet steel boxes and containers combine sturdiness, quality and economy. The extremely robust container systems are highly resistant to mechanical loads.

As a consequence, heavy goods such as solid materials, cast or forged parts can be transported, stored and picked safely and efficiently.

Whether for production preparation, the warehouse, shipping companies, order-picking or transport, sheet steel boxes and sheet steel containers can always fulfill the most demanding standards.





Sheet steel boxes and containers

Appendix	Logistics systems	Semi-automated solutions	On-line shelving / KDR shelving	Mezzanines / platforms	Cantilever racking	Pallet racking	Longspan racking	Modular shelving	Boxes / containers
----------	-------------------	--------------------------	---------------------------------	------------------------	--------------------	----------------	------------------	------------------	--------------------

Semi-open front storage containers – 14/7 range made of sheet steel



BLUE-GRAY



PAINTED

SHEET STEEL



GALVANIZED*





- ▶ **Sheet steel**
for high mechanical loads, painted blue-gray or immersion galvanized
- ▶ **High stacking loads**
- ▶ **Stackable**
with LF series made of plastic, 14/6 range made of plastic and steel
- ▶ **Very sturdy**
due to the rolled stacking rim

* Surface quality: galvanized acc. to DIN EN ISO 1461



Sheet steel semi-open front storage containers – 14/7 range

Item	Nominal dimensions L x W x H (mm)	Max. load (kg)		Volume (liters)	Order No.	
		Single	Stacked			
14/7-5 I	165/136 x 95 x 75	2.5	25	0.9	6930	–
14/7-5 v					–	6940
14/7-4 I	235/200 x 140 x 128	8	120	3.5	6890	–
14/7-4 v					–	6900
14/7-3 Z I	353/300 x 200 x 145	60	600	8.0	6850	–
14/7-3 Z v					–	6860
14/7-3 I	352/300 x 200 x 200	60	1,000	11.5	6810	–
14/7-3 v					–	6820
14/7-2 H I	503/450 x 300 x 142	80	600	17.0	6770	–
14/7-2 H v					–	6780
14/7-2 I	515/450 x 300 x 200	120	1,200	26.0	6720	–
14/7-2 v					–	6730
14/7-2 Z I	540/450 x 300 x 300	150	1,500	41.0	6690	–
14/7-2 Z v					–	6700
14/7-1 Z I	538/450 x 450 x 300	150	1,500	60.0	6670	–
14/7-1 Z v					–	6680
14/7-1 I	720/630 x 450 x 295	180	2,500	83.0	6650	–
14/7-1 v					–	6660

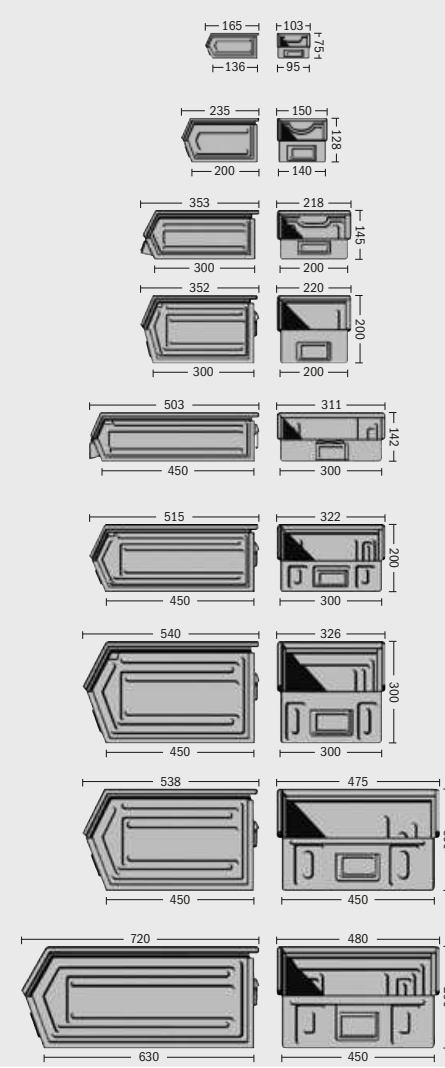

Order No. = on stock

Order No. = not on stock

Accessories for 14/7 range made of sheet steel



Dividers

Galvanized sheet steel for lengthwise partitioning of the containers.

Item	for containers	PU	Order No.
ZW-3-B	14/7-3	1 divider and 1 pair of slotted strips	7050
ZW-2-B	14/7-2	1 divider and 1 pair of slotted strips	7040
ZW-1-B	14/7-1	1 divider and 1 pair of slotted strips	7030

Boxes /
containers

Modular
shelving

Longspan
racking

Pallet
racking

Cantilever
racking

Mezzanines /
platforms

On-line shelving /
KDR shelving

Semi-automated
solutions

Logistics
systems

Appendix

i

BLUE-GRAY **SHEET STEEL**

PAINTED **GALVANIZED***



- ▶ **Sheet steel**
for high mechanical loads, painted blue-gray or immersion galvanized
- ▶ **High stacking loads**
- ▶ **Stackable**
with LF series made of plastic, 14/7 range made of steel, 14/6 range made of plastic
- ▶ **Very sturdy**
due to the rolled stacking rim

* Surface quality: galvanized acc. to DIN EN ISO 1461





Stackable transportation containers – 14/6 range made of sheet steel

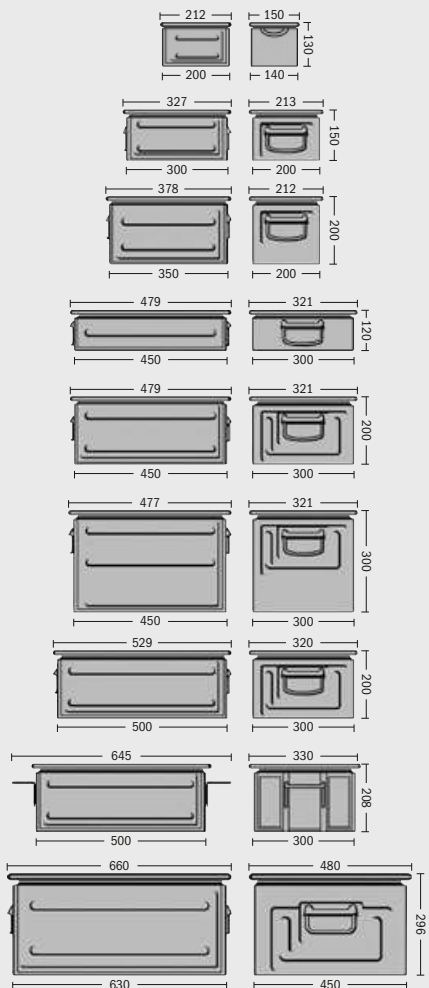

Sheet steel stackable transport containers – 14/6 range



Item	Nominal dimensions L x W x H (mm)	Max. load (kg)		Volume (liters)	Order No.	
		Single	Stacked			
14/6-4 I	200 x 140 x 130	8	120	3.2	8130	–
14/6-4 v					–	8140
14/6-3 I	300 x 200 x 150	60	1,000	8.0	8100	–
14/6-3 v					–	8110
14/6-B I	350 x 200 x 200	80	1,000	12.8	8180	–
14/6-B v					–	8190
14/6-2 H I	450 x 300 x 120	100	1,000	14.2	16520	–
14/6-2 H v					–	16540
14/6-2 I	450 x 300 x 200	120	1,200	24.9	8070	–
14/6-2 v					–	8080
14/6-2 Z I	450 x 300 x 300	150	1,200	38.4	15880	–
14/6-2 Z v					–	15890
14/6-A I	500 x 300 x 200	120	1,200	27.7	8160	–
14/6-A v					–	8170
10/6-b I	500 x 300 x 208	200	1,500	27.4	8270	–
10/6-b v					–	8280
	for heavy loads, fixed handle and drag rails					
14/6-1 I	630 x 450 x 296	250	2,500	79.0	8050	–
14/6-1 v					–	8060

Order No. = on stock

Order No. = not on stock

Special perforated versions 14/6 series and accessories made of sheet steel

Special perforated versions 14/6 series

With ergonomically shaped flip handles on short sides for comfortable handling despite heavy contents. Highly suitable for safe working during transportation, ongoing warehouse operation, or even outside.

Sheet steel, galvanized. Optimal for the washing process and suitable for all shelving systems. Thanks to a robust stacking rim and base, the containers ensure a high level of stability when stacked.

Hole patterns 111

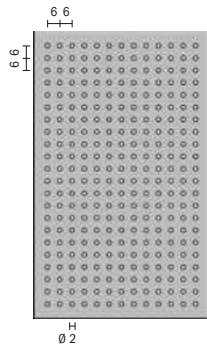

Ao = 8.7%

Hole patterns 112 B

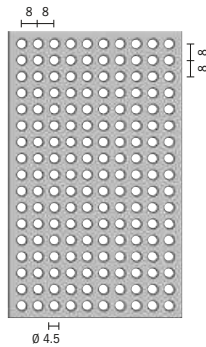

Ao = 24.8%

Hole patterns 113 B

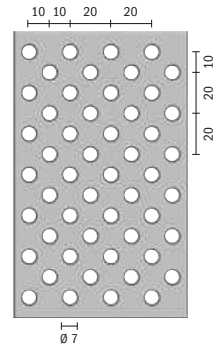

Ao = 19%

For technical data please refer to the table on page A58.

Item	Order no.	Item	Order no.	Item	Order no.
14/6-2 v with hole patterns 111	8800004	14/6-2 v with hole patterns 112 B	8802014	14/6-2 v with hole patterns 113 B	8800014

Dust lids with finger hole

Galvanized sheet steel. Recommended for intra-company transport of dust-sensitive articles.

PU: 10 items

* Surface quality: galvanized acc. to DIN EN ISO 1461



Item	for containers	Order No.
SD-14/6-1 v	14/6-1	9320
SD-14/6-A v	14/6-A	9338



SHEET STEEL SHEET STEEL



Sheet steel shelf containers

- ▶ Designed for SSI SCHAEFER modular shelvings
- ▶ Extensive range of order accessories labeling and partition options (advantageous for both large and small warehouses)

* Surface quality: galvanized acc. to DIN EN ISO 1461



Plastic shelf containers

from page A10

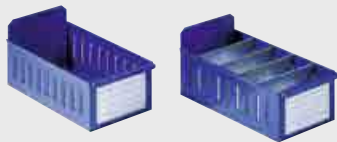
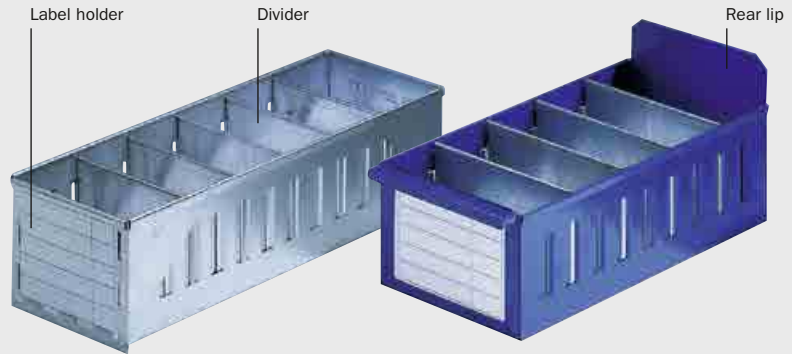

RK 301 Steel, painted blue

can be divided into max. 10 compartments, 6 containers per shelf.

Item	Description (W x D x H mm)	PU	Order No.
RK 301	Shelf container (162 x 317 x 100/137)	1 pc.	11550
RKE 386	Labels for short side	100 pcs.	11190
RKF 386	Protective film	100 pcs.	11920
RKT 335/301	Divider, galvanized	1 pc.	11150

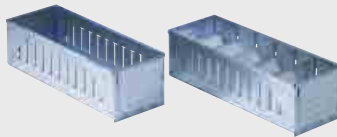

RK 2386 Steel, galvanized

can be divided into max. 12 compartments, 7 containers per shelf.

Item	Description (W x D x H mm)	PU	Order No.
RK 2386	Shelf container (136 x 393 x 100/107)	1 pc.	18240
RKE 2386	Labels for short side	100 pcs.	11560
RKF 2386	Protective film	100 pcs.	11570
RKT 2386	Divider, galvanized	1 pc.	18250

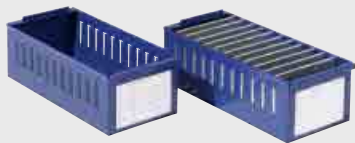

RK 4386 Steel, painted blue

can be divided into max. 12 compartments, 6 containers per shelf.

Item	Description (W x D x H mm)	PU	Order No.
RK 4386	Shelf container (162 x 398 x 120/137)	1 pc.	18000
RKE 386	Labels for short side	100 pcs.	11190
RKF 386	Protective film	100 pcs.	11920
RKT 386/512/4386	Divider, galvanized	1 pc.	11180

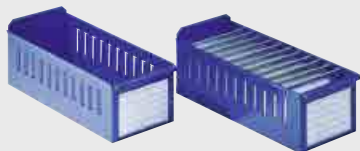

RK 386 Steel, painted blue

can be divided into max. 12 compartments, 6 containers per shelf.

Item	Description (W x D x H mm)	PU	Order No.
RK 386	Shelf container (162 x 404 x 120/137)	1 pc.	11170
RKE 386	Labels for short side	100 pcs.	11190
RKF 386	Protective film	100 pcs.	11920
RKT 386/512/4386	Divider, galvanized	1 pc.	11180

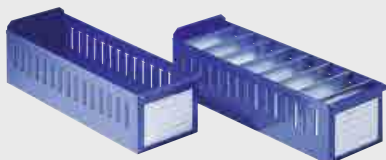

RK 512 Steel, painted blue

can be divided into max. 16 compartments, 6 containers per shelf.

Item	Description (W x D x H mm)	PU	Order No.
RK 512	Shelf container (162 x 504 x 120/137)	1 pc.	16210
RKE 386	Labels for short side	100 pcs.	11190
RKF 386	Protective film	100 pcs.	11920
RKT 386/512/4386	Divider, galvanized	1 pc.	11180



Order No. = on stock

- ▶ **Sheet steel**
for storage and transport of heavy goods, e.g. solid materials, cast and forged parts
- ▶ **High load capacity**
due to right-angled profile and strongly compressed walls
- ▶ **Strong base**
- ▶ **Safe stacking**
as a result of reinforced feet and solid support and stacking corners



* Surface quality: galvanized acc. to DIN EN ISO 1461

Transport and stackable containers

E transport and stacking containers

Transport and stacking containers with solid walls or with flap. Strongly compressed walls with a right-angled profile guarantee high capacity with low empty weight. Extra reinforced feet together with solid catch and stacking corners ensure reliable stacking.

Base version: painted or galvanized, with base ribbing

Ground clearance: 105 mm

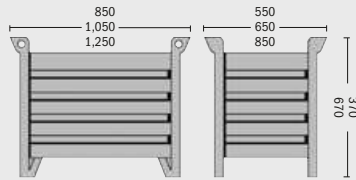

Item	Nominal dimensions L x W x H (mm)	External dimensions L x W x H (mm)	Width of fork opening L x W (mm)	Load (kg)	Stacking factor	Order No.	Item	Order No.
1286 K-I*	1,200 x 800 x 605	1,250 x 850 x 670	1,000 x 700	1,500	1 + 4	8590	1286 K-v*	8600
1286-I**	1,200 x 800 x 605	1,250 x 850 x 670	1,000 x 700	1,500	1 + 5	8610	1286-v**	8620
866 K-I*	800 x 600 x 605	850 x 650 x 670	600 x 510	800	1 + 4	8630	866 K-v*	8640
866-I**	800 x 600 x 605	850 x 650 x 670	600 x 510	800	1 + 5	8650	866-v**	8660
186 K-I*	1,000 x 800 x 605	1,050 x 850 x 670	800 x 700	1,500	1 + 5	8470	186 K-v*	8480
186-I**	1,000 x 800 x 605	1,050 x 850 x 670	800 x 700	1,500	1 + 5	8490	186-v**	8500
856 K-I*	800 x 500 x 605	850 x 550 x 670	600 x 410	800	1 + 4	8510	856 K-v*	8520
856-I**	800 x 500 x 605	850 x 550 x 670	600 x 410	800	1 + 5	8530	856-v**	8540
853-I**	800 x 500 x 305	850 x 550 x 370	600 x 410	500	1 + 9	8550	853-v**	8560

* With flap, ** Solid walls

S transport and stacking containers

Transport and stacking containers for all heavy goods, solid material, cast and forged parts. The side walls have a tube-shaped profile at the top and reinforcing beads. In addition, the containers also feature continuous ribbing around the sides, a strong base, sturdy feet and especially strong stacking corners with crane lugs.

Ground clearance: 100 mm*
Ground clearance: 105 mm**

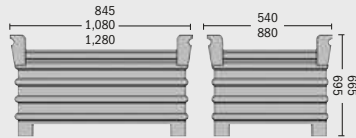

Item	Nominal dimensions L x W x H (mm)	External dimensions L x W x H (mm)	Width of fork opening L x W (mm)	Load (kg)	Stacking factor	Order No.	Item	Order No.
S 1286-I**	1,200 x 800 x 605	1,280 x 880 x 695	1,000 x 600	2,000	1 + 5	8670	S 1286-v	8680
S 1086-I**	1,000 x 800 x 605	1,080 x 880 x 695	800 x 600	2,000	1 + 5	8690	S 1086-v	8700
S 856-I*	800 x 500 x 605	845 x 540 x 665	660 x 330	1,000	1 + 3	8710	S 856-v	8720

SG transport and stacking containers

Robust and sturdy containers with fork pockets and extra-wide stacking corners.

Ground clearance: 150 mm (SG 1216-I+v and SG 1286-I+v), 120 mm (SG 1086-I+v).

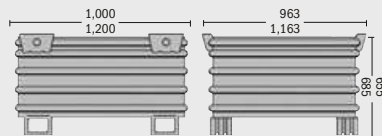

Item	Nominal dimensions L x W x H (mm)	External dimensions L x W x H (mm)	Width of fork opening L x W (mm)	Load (kg)	Stacking factor	Order No.	Item	Order No.
SG 1216-I	1,200 x 1,000 x 650	1,200 x 1,163 x 685	600 x 680	2,000	1 + 4	8730	SG 1216-v	8740
SG 1286-I	1,200 x 800 x 650	1,200 x 963 x 685	600 x 480	2,000	1 + 4	8750	SG 1286-v	8760
SG 1086-I	1,000 x 800 x 620	1,000 x 963 x 655	600 x 600	2,000	1 + 4	8770	SG 1086-v	8780

Boxes / containers

Modular shelving

Longspan racking

Pallet racking

Cantilever racking

Mezzanines / platforms

On-line shelving / KDR shelving

Semi-automated solutions

Logistics systems

Appendix



PAINTED



GALVANIZED*

* Surface quality: galvanized acc. to DIN EN ISO 1461



Lager-Fix containers, post pallets and flat steel pallets

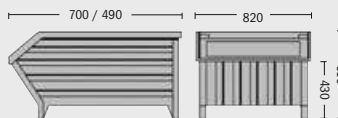

Lager-Fix container

These containers utilize the principles and design of the proven Lager-Fix semi-open front storage container. The large viewing and access opening is especially advantageous and remains accessible even when the container is stacked. That is why this container is also utilized for the staging of the material on the production line.

The stacking rim runs around three sides and enables safe stacking of up to 4 units on top of each other. Mixed stacks of different sizes are possible. The right-angled profile and the strongly compressed walls guarantee high load capacity.

Ground clearance 105 mm.
Height of hopper front 430 mm.

Item	Nominal dimensions L x W x H (mm)	External dimensions L x W x H (mm)	Width of fork opening L x W (mm)	Load (kg)	Stacking factor	Order No.	Item	Order No.
14/7-0a-I	700/490 x 800 x 610	710 x 820 x 610	290 x 720	800	1 + 3	8790	14/7-0a-v	8800

Post pallets

Clear storage and easy transportation of production and assembly parts with large dimensions that exceed the limited container volume. Stand made of square tube 50 x 50 x 3 mm with welded stacking corners.

Ground clearance 100 mm.

Base reinforced with strong ribbing.

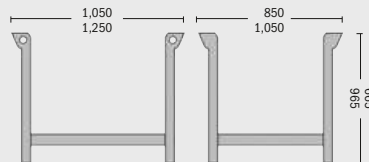

Item	Nominal dimensions L x W x H (mm)	External dimensions L x W x H (mm)	Width of fork opening L x W (mm)	Load (kg)	Stacking factor	Order No.	Item	Order No.
R 1086-I	1,000 x 800 x 600	1,050 x 850 x 665	900 x 700	1,000	1 + 3	9180	R 1086-v	9190
R 1286-I	1,200 x 800 x 600	1,250 x 850 x 665	1,100 x 700	1,000	1 + 3	9200	R 1286-v	9210
R 1216-I	1,200 x 1,000 x 600	1,250 x 1,050 x 665	1,100 x 900	1,000	1 + 3	9220	R 1216-v	9230
R 1089-I	1,000 x 800 x 900	1,050 x 850 x 965	900 x 700	1,000	1 + 2	9240	R 1089-v	9250
R 1289-I	1,200 x 800 x 900	1,250 x 850 x 965	1,100 x 700	1,000	1 + 2	9260	R 1289-v	9270
R 1219-I	1,200 x 1,000 x 900	1,250 x 1,050 x 965	1,100 x 900	1,000	1 + 2	9280	R 1219-v	9290

Flat steel pallets

4-way entry pallet made with a strong base ripping with 2 or 3 sheet steel skids securely supported by the container profiles.

Alternating stacks due to the flat skids.

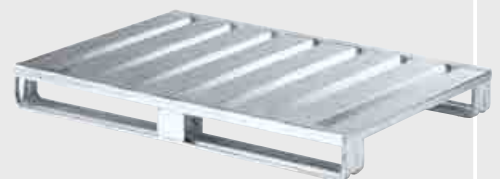

Item	Nominal dimensions L x W x H (mm)	Load (kg)	Number of skids	Order No.	Item	Order No.
SP 1282 F-I	1,200 x 800 x 132	1,500	2	9060	SP 1282 F-v	9070
SP 1283 F-I	1,200 x 800 x 132	2,500	3	9080	SP 1283 F-v	9090

Order No. = on stock

Order No. = not on stock

Special steel solutions

We can also meet individual customer requirements with our special steel solutions. We would be happy to work with you to develop the perfect solution – completely tailored to your exact needs. From the initial draft by our designers to

the prototypes made by our specialists and right through to series production in our modern factory, we are your expert partner.

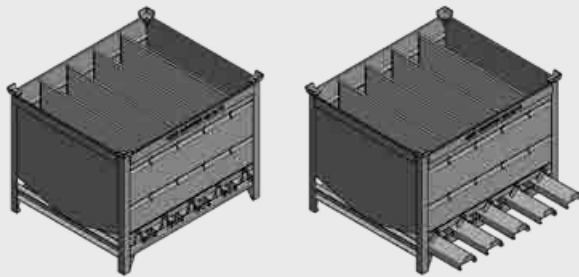

Stacking container with bottom slider

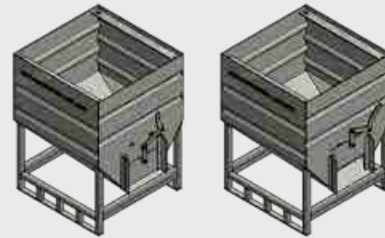

Funnel container with slider



Rack for coils



Container with extendable side walls

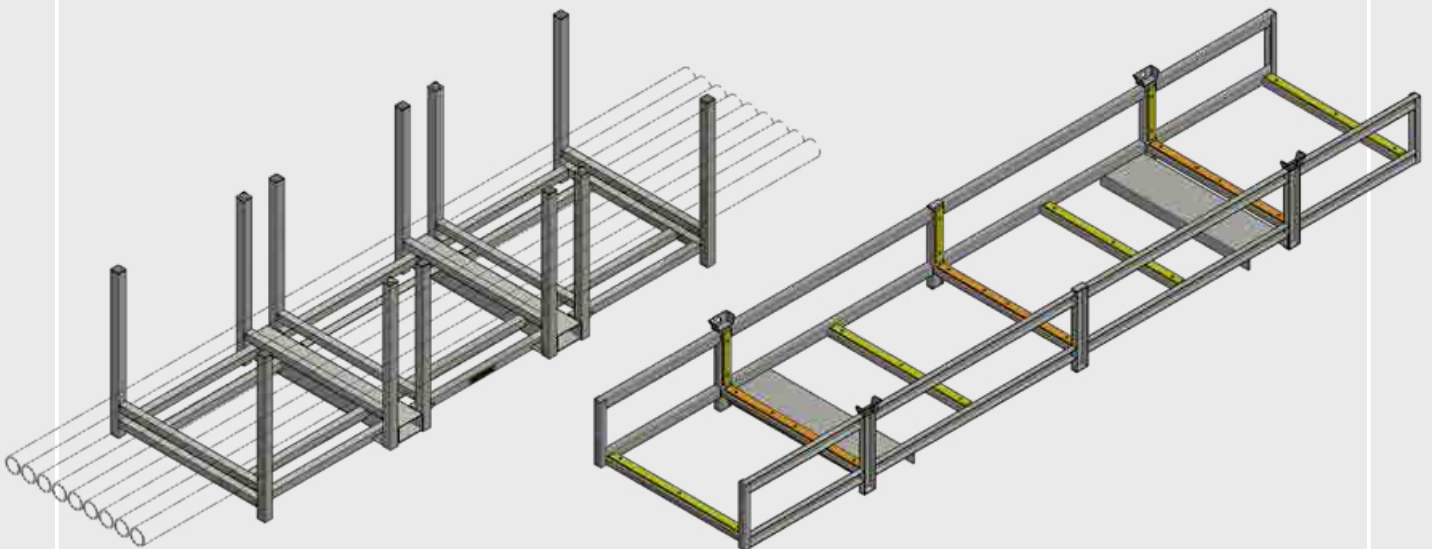

Long material rack

Boxes /
containers

Modular
shelving

Longspan
racking

Pallet
racking

Cantilever
racking

Mezzanines /
platforms

On-line shelving /
KDR shelving

Semi-automated
solutions

Logistics
systems

Appendix