

# SSI ORBITER®

Maximum performance in channel storage systems:  
Safe, fast, intelligent and connected

[ssi-schaefer.com](https://www.ssi-schaefer.com)





# A COMPACT WINNER OPTIMUM UTILIZATION OF SPACE

Increasing order numbers and the associated need for efficient storage options for pallets of varying depths requires flexible, space-saving systems. The changing market requirements demand the top to bottom optimization of entire storage volume - while at the same time achieving a high level of efficiency and cost-effectiveness.

Channel storage systems concentrate on maximizing the use of space while keeping operating costs low. Thanks to the compacted storage, they use the available space perfectly.

This technology is particularly well suited to handling large amounts of items with low diversity, such as in the food and beverage industry or in temperature-controlled environments that require a lot of power.

With the SSI Orbiter, SSI SCHAEFER has both semi-automatic and fully-automatic systems to achieve greater availability, service quality and supply capability, in addition to efficient utilization of space.

## ADVANTAGES OF A CHANNEL STORAGE SYSTEM

- **Performance**  
Parallel work steps create high picking performance
- **Scalability**  
If the stock turnover needs to be increased later, adding additional channel vehicles is simple and straightforward
- **Availability**  
Using multiple channel vehicles ensures the optimum utilization of the system
- **Cost and energy efficiency**  
The high level of space utilization minimizes operating costs. The high storage density creates maximum energy efficiency
- **Durability and safety**  
Work is only carried out at the ends of the channels

# CHANNEL STORAGE SYSTEM: A SPACE-SAVING MIRACLE

Channel storage systems enable compact storage. Several storage units are included one after the other in channels. The operation of the system is carried out by channel vehicles. Only the loading unit at the very front of each channel can be

accessed. For this reason, this system is most suited to large volumes with low item diversity. The channels are therefore usually filled with a single item.



# SSI ORBITER - THE OPTIMAL SOLUTION

In semi-automatic applications, when connected to a docking station, the innovative SSI Orbiter offers optimal utilization of space alongside extremely high flexibility,

maximum personal safety, sustainability, and ease of use in the channel storage system. It also enables vastly improved pallet handling efficiency.

## Safe

- The docking station remains at the front of the channel, restricting access to the channel
- Safe transport in the warehouse - the Orbiter locks onto the docking station when transferring between channels
- Maximum safety in the warehouse thanks to the integrated Safety PLC

## Flexible

- Mixed FIFO/FILO operation possible within the same warehouse
- Various pallet types can be handled
- Can be implemented as either a semi-automated or fully automated system
- Suitable for use in earthquake-prone areas
- Suitable for use in deep-freeze environments

## User-Friendly and efficient

- Simple and fast insertion into a rack thanks to precisely measured entry tolerances
- User-friendly operation thanks to pictograms on the remote control
- Parallel use of multiple SSI Orbiter creates maximum efficiency

Compact. More compact. Channel storage system.

**50% - PALLET RACKS**

**90% - MOBILE RACKS**

**100% - CHANNEL  
STORAGE SYSTEM**



# COMPONENT OVERVIEW

## Docking Station

- Central safety device with status indicators
- Impedes unauthorized access of the channel
- Safe and gentle transport of the Orbiter
- Easy insertion into docking station thanks to generous entry tolerances
- Can be used with all types of bin stacker

### Docking station

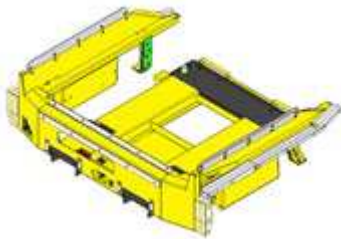

### Docking station with Orbiter

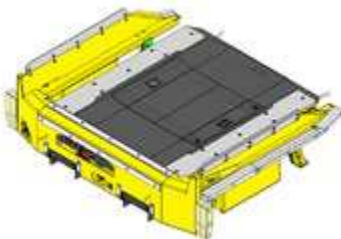

### Charging cabinet for batteries

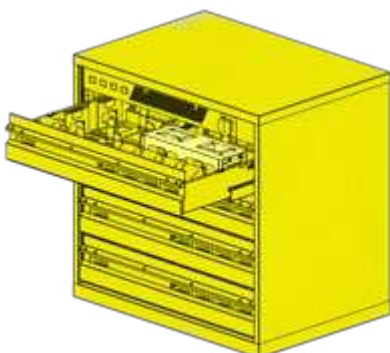

## SSI Orbiter

- Integrated safety PLC and sensor system with redundancy
- Innovative lifting mechanism without hydraulics
- High-resolution regulated drives for maximum performance
- Intelligent system with comprehensive operating options
- Eight wheels minimize wear
- Grid-independent and fast, manual battery changing
- Low investment costs and up to 16 operating hours per battery charge possible

## Rail Design

- Robust and durable rail design
- Designed for more than 100,000 cycles

### Battery

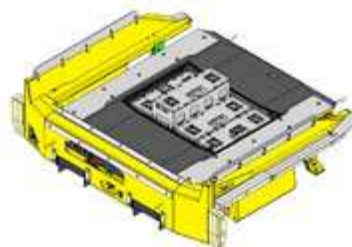

## Radio Remote Control

- System independence
- Fast control of the system
- Flexible choice of operating modes
- Simple operation using pictograms
- Can be connected to bin stacker batteries
- Simultaneous control of multiple Orbiters

Radio remote control



Retrieval platform

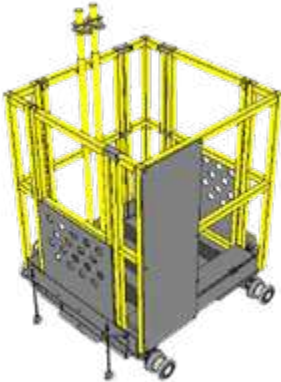

## Safety Components

- Fence ensures the highest level of safety
- Longer rack service life by preventing damages thanks to ground approach strip
- Retrieval platform for easy error rectification in the channel

Rack



# SSI ORBITER: HOW IT WORKS

1. Bin stackers pick up the docking station and the Orbiter and insert it into the centering console of the required rack channel. The channel storage system is fully functional even with just one Orbiter.



2. The pallets to be loaded are picked up by the bin stacker and placed on the Orbiter.

3. Movement commands are transmitted to the channel vehicle using a wireless remote control. The Orbiter collects the pallets with a small lift and transports it to the next available storage location in the channel.



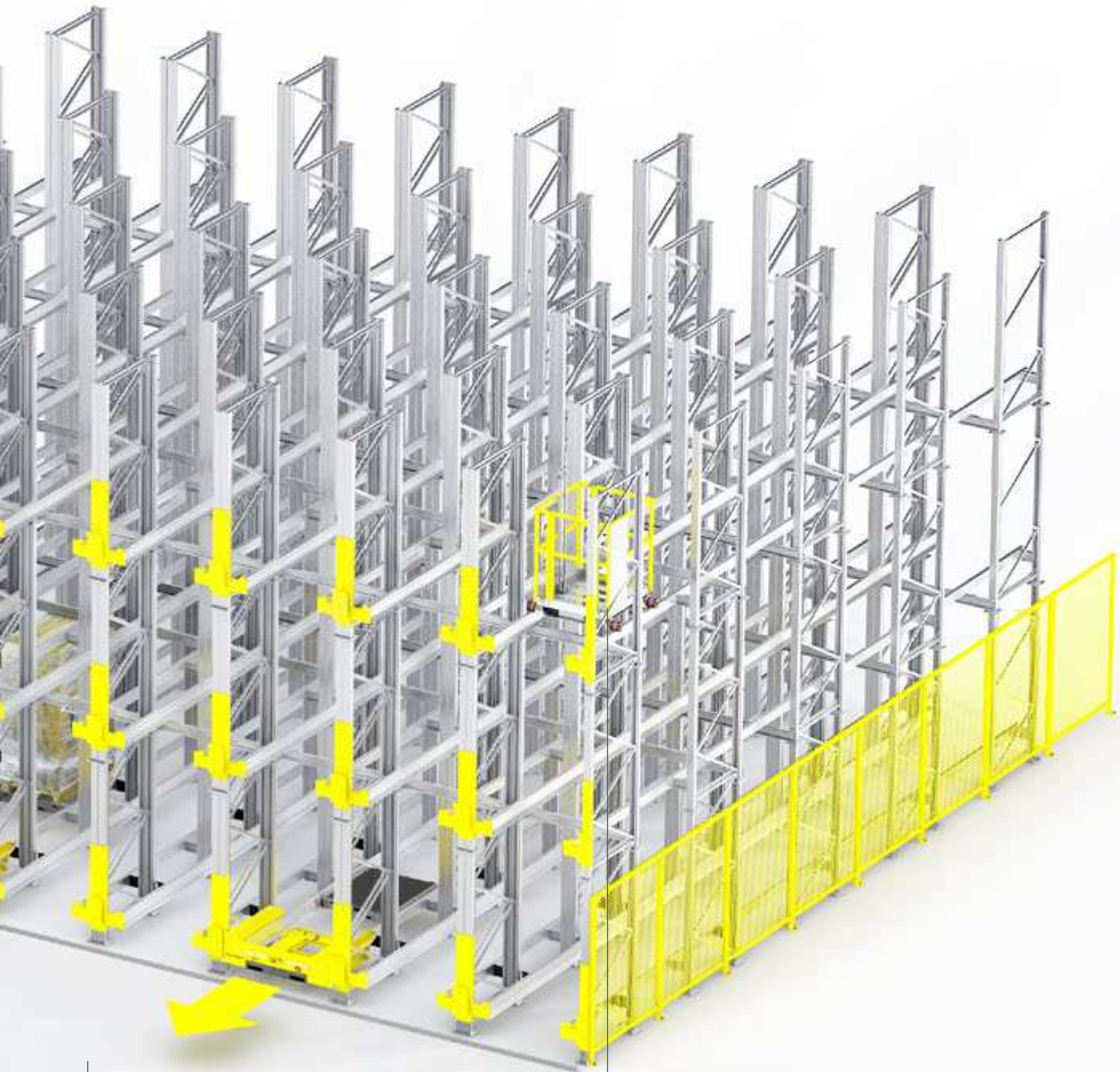

4. After unloading the pallets, the Orbiter automatically returns to the docking station. The functional unit consisting of docking station and Orbiter can be used in a different channel straight away.

5. Components such as retrieval platforms and safety fences guarantee the highest level of personal safety.

# SSI ORBITER MODELS

## FIRST IN LAST OUT (FILO)

The FILO principle is what allows the most compact type of storage in a channel storage system. This principle means that goods stored first are the last to be removed again. One-sided storage and retrieval means it is also the most resource efficient form of storage.

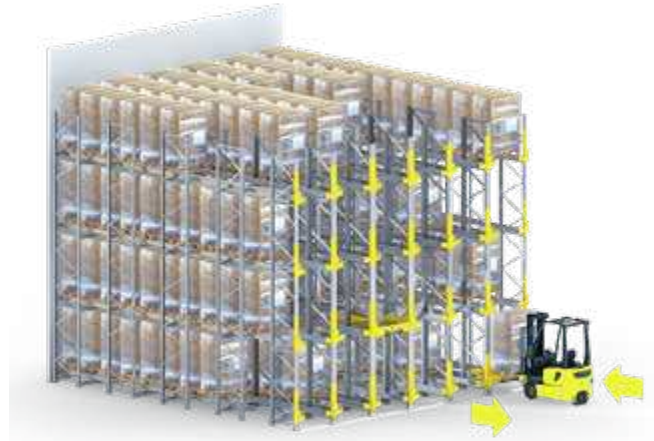

## FIRST IN FIRST OUT (FIFO)

If perishable goods are being stored, the rack must be designed so that it can be operated from both sides according to the FIFO principle. This means that the goods that were stored first are also the first to be removed again. If two channel vehicles are being used in the same channel at the same time, a special anti-collision system in the Orbiter prevents any accidents.

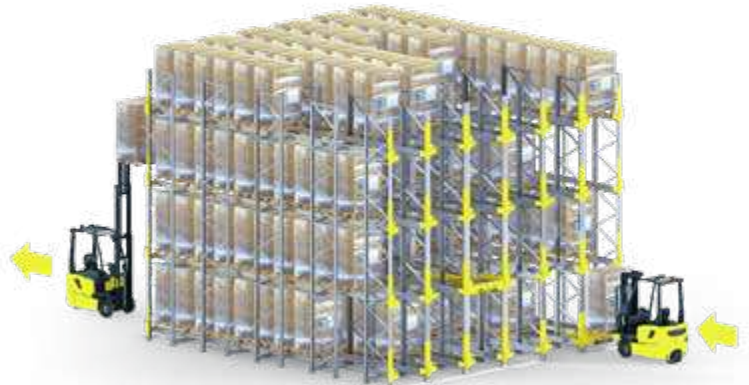

## PICKING SOLUTION

It is also possible to combine the rack with various solutions for picking goods. For example, a tunnel can be integrated into the rack to allow goods to be loaded from both sides and picked to order.

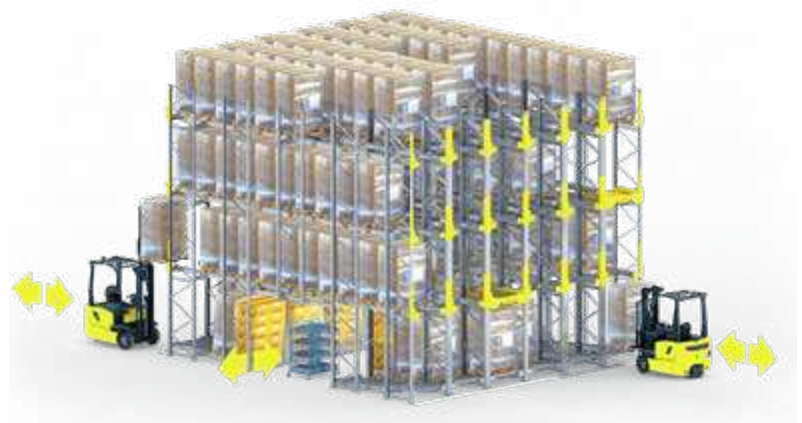

## AUTOMATED GUIDED VEHICLE SOLUTION

The Orbiter can also be used in combination with an automated guided vehicle (AGV). SSI SCHAEFER's fleet of AGVs includes a variety of innovative solutions that enable the barrier-free networking of different warehouse and work areas, and that can be adapted to the customers' needs and extended as required.



## CLEANING SOLUTION

In order to guarantee increased hygiene and cleanliness in the warehouse area, the lowest level is designed for end-to-end accessibility has standard. The base of the rack can therefore be easily accessed with cleaning machines.

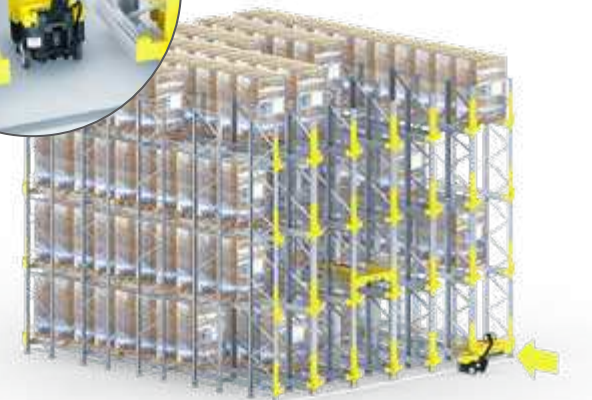

# TRIED-AND-TESTED SYSTEMS - IN USE AROUND THE WORLD



## Arla a.m.b.a.

Location	DK, Videbaek
Industry	Dairy products
Storage locations	8,278
Number of Orbiters	14
Temperature range	Ambient
Storage principle	FIFO/FILO
Orbiter type	Power Cap

## A. O. Smith India

Location	IN, Ramnagar (Karnataka)
Industry	Hot water production systems
Storage locations	4,401
Number of Orbiters	3
Temperature range	Ambient
Storage principle	FIFO
Orbiter type	Battery



## Saline de Bex SA

Location	CH, Bex
Industry	Salt
Storage locations	756
Number of Orbiters	3
Temperature range	Ambient
Storage principle	FILO
Orbiter type	Power Cap

## LGI

Location	DE, Hünxe
Industry	3PL
Storage locations	30,000
Number of Orbiters	27
Temperature range	Ambient
Storage principle	FILO
Orbiter type	Power Cap

# SSI ORBITER LHD

Fully automated channel storage systems are an outstanding solution for achieving a higher level of storage space utilization in comparison to conventional single- or double-depth high bay warehouses. A more efficient use of energy rounds off the system and makes it an interesting alternative to the semi-automated application.

The load handling device SSI Orbiter LHD by SSI SCHAEFER can be used with both the universal Exyz storage and retrieval machine and Schäfer Lift & Run system in temperatures ranging from sub-zero (-30 °C) to warm (+45 °C) at a maximum load capacity of 1,500 kg.

The dynamic solution is characterized by an extremely flat design and uncompromising vehicle dynamics. In addition, a specially developed energy management system using power caps guarantees maximum energy efficiency, even for 24/7 operation.

Combined with our proprietary logistics software WAMAS®, the handling processes are optimally controlled and high levels of technical performance are achieved. The scalable layout allows individual customer requirements to be catered for.



## ADVANTAGES

- Highly efficient, dynamic pallet storage in a channel storage system
- Individual, scalable, and modular warehouse layouts
- Significant improvement of the turnover performance with no loss of storage space with the Schäfer Lift&Run system
- Excellent vehicle dynamics and extremely flat design
- Maximum energy efficiency
- Optimal safety functions as standard, including steelwork features
- Access to all storage bins even during maintenance work
- Maximum load capacity of 1,500 kg





## **FLEXIBLE SOLUTION MODULES**

The combined usage of the storage and retrieval machine Exyz and the SLR system is also possible with the SSI Orbiter LHD. This flexible combination means that an efficient, dynamic, and cost-effective solution that is ideally suited to each customer's individual needs can be created.



## SIX REASONS FOR CHOOSING SSI SCHAEFER:

- **Stability:**

As a financially independent family business, SSI SCHAEFER is committed to long-term solutions. You can trust that our team of experts will be there for you today, tomorrow and in years to come.

- **Efficiency:**

SSI SCHAEFER solutions are scalable and able to grow with your business. You can always upgrade or retrofit.

- **Quality:**

As a systems specialist and original equipment manufacturer, SSI SCHAEFER provides tailor-made and high-quality solutions from a single source, specifically designed to meet your challenges.

- **Reliability:**

Thanks to our worldwide Customer Service & Support network, SSI SCHAEFER ensures smooth operation of your system, both during and after installation.

- **Know-how:**

SSI SCHAEFER solutions are always up-to-date with the latest technological standards and can be easily integrated into an existing (IT) landscape.

- **Internationality:**

As a global organization, SSI SCHAEFER has local offices worldwide. With over 70 operative subsidiaries, our team of experts speak your language.

[ssi-schaefer.com](https://www.ssi-schaefer.com)

0367\_18 EN © SSI SCHAEFER  
Printed in Germany.  
No liability for misprints.

**SSI SCHAEFER**